

NCE N-Channel Enhancement Mode Power MOSFET

Description

The VCRR6030K uses **advanced trench technology and design** to provide excellent $R_{DS(ON)}$ with low gate charge. It can be used in a wide variety of applications.

General Features

- $V_{DS} = 60V, I_D = 30A$
 $R_{DS(ON)} < 27m\Omega @ V_{GS} = 10V$
- High density cell design for ultra low R_{dson}
- Fully characterized avalanche voltage and current
- Good stability and uniformity with high E_{AS}
- Excellent package for good heat dissipation
- Special process technology for high ESD capability

Application

- Power switching application
- Hard switched and high frequency circuits
- Uninterruptible power supply

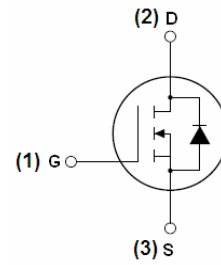

Schematic diagram

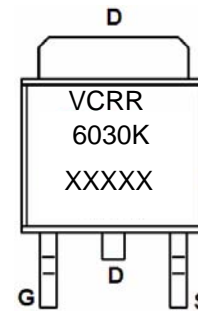

Marking and pin assignment

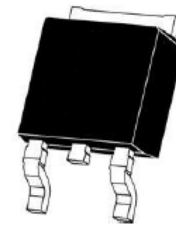

TO-252-2L top view

Package Marking and Ordering Information

Device Marking	Device	Device Package
VCRR6030K		TO-252-2L

Absolute Maximum Ratings ($T_C = 25^\circ C$ unless otherwise noted)

Parameter	Symbol	Limit	Unit
Drain-Source Voltage	V_{DS}	60	V
Gate-Source Voltage	V_{GS}	± 20	V
Drain Current-Continuous	I_D	30	A
Drain Current-Continuous($T_C = 100^\circ C$)	$I_D(100^\circ C)$	20	A
Pulsed Drain Current	I_{DM}	74	A
Maximum Power Dissipation	P_D	50	W
Derating factor		0.33	W/ $^\circ C$
Single pulse avalanche energy ^(Note 5)	E_{AS}	144	mJ
Operating Junction and Storage Temperature Range	T_J, T_{STG}	-55 To 175	$^\circ C$

Thermal Characteristic

Thermal Resistance, Junction-to-Case ^(Note 2)	$R_{\theta JC}$	3	$^{\circ}\text{C/W}$
--	-----------------	---	----------------------

Electrical Characteristics ($T_C=25^{\circ}\text{C}$ unless otherwise noted)

Parameter	Symbol	Condition	Min	Typ	Max	Unit
Off Characteristics						
Drain-Source Breakdown Voltage	BV_{DSS}	$V_{GS}=0V, I_D=250\mu A$	60	-	-	V
Zero Gate Voltage Drain Current	I_{DSS}	$V_{DS}=60V, V_{GS}=0V$	-	-	1	μA
Gate-Body Leakage Current	I_{GSS}	$V_{GS}=\pm 20V, V_{DS}=0V$	-	-	± 100	nA
On Characteristics ^(Note 3)						
Gate Threshold Voltage	$V_{GS(th)}$	$V_{DS}=V_{GS}, I_D=250\mu A$	1.4	1.8	2.5	V
Drain-Source On-State Resistance	$R_{DS(ON)}$	$V_{GS}=10V, I_D=20A$	-	23	27	m Ω
Forward Transconductance	g_{FS}	$V_{DS}=5V, I_D=20A$	-	30	-	S
Dynamic Characteristics ^(Note 4)						
Input Capacitance	C_{iss}	$V_{DS}=30V, V_{GS}=0V,$ $F=1.0\text{MHz}$	-	1900	-	PF
Output Capacitance	C_{oss}		-	130	-	PF
Reverse Transfer Capacitance	C_{rss}		-	95	-	PF
Switching Characteristics ^(Note 4)						
Turn-on Delay Time	$t_{d(on)}$	$V_{DS}=30V, R_L=1.5\Omega$ $V_{GS}=10V, R_G=3\Omega$	-	5	-	nS
Turn-on Rise Time	t_r		-	2.6	-	nS
Turn-Off Delay Time	$t_{d(off)}$		-	16.1	-	nS
Turn-Off Fall Time	t_f		-	2.3	-	nS
Total Gate Charge	Q_g	$V_{DS}=30V, I_D=20A,$ $V_{GS}=10V$	-	30	-	nC
Gate-Source Charge	Q_{gs}		-	4.5	-	nC
Gate-Drain Charge	Q_{gd}		-	7.5	-	nC
Drain-Source Diode Characteristics						
Diode Forward Voltage ^(Note 3)	V_{SD}	$V_{GS}=0V, I_S=30A$	-	-	1.2	V
Diode Forward Current ^(Note 2)	I_S		-	-	30	A
Reverse Recovery Time	t_{rr}	$T_J = 25^{\circ}\text{C}, I_F = 20A$ $di/dt = 100A/\mu s$ ^(Note 3)	-	35	-	nS
Reverse Recovery Charge	Q_{rr}		-	53	-	nC
Forward Turn-On Time	t_{on}	Intrinsic turn-on time is negligible (turn-on is dominated by LS+LD)				

Notes:

1. Repetitive Rating: Pulse width limited by maximum junction temperature.
2. Surface Mounted on FR4 Board, $t \leq 10$ sec.
3. Pulse Test: Pulse Width $\leq 300\mu s$, Duty Cycle $\leq 2\%$.
4. Guaranteed by design, not subject to production
5. EAS condition: $T_J=25^{\circ}\text{C}, V_{DD}=30V, V_G=10V, L=0.5\text{mH}, R_g=25\Omega$

Test Circuit

1) E_{AS} test Circuit

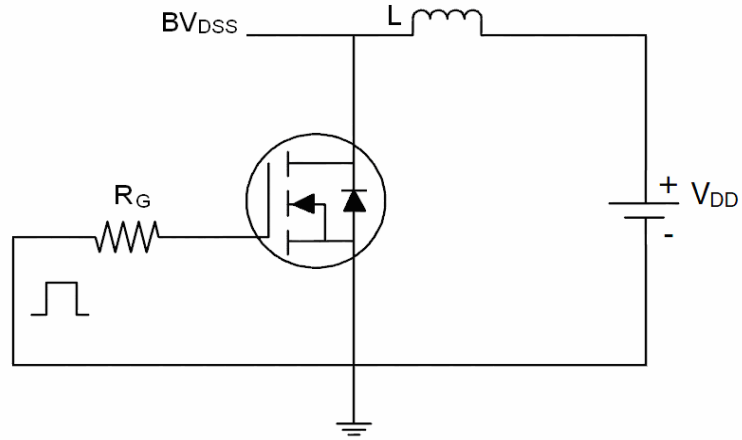

2) Gate charge test Circuit

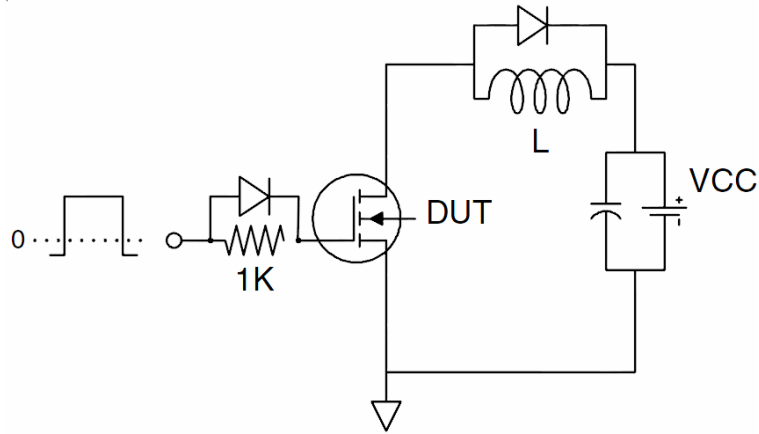

3) Switch Time Test Circuit

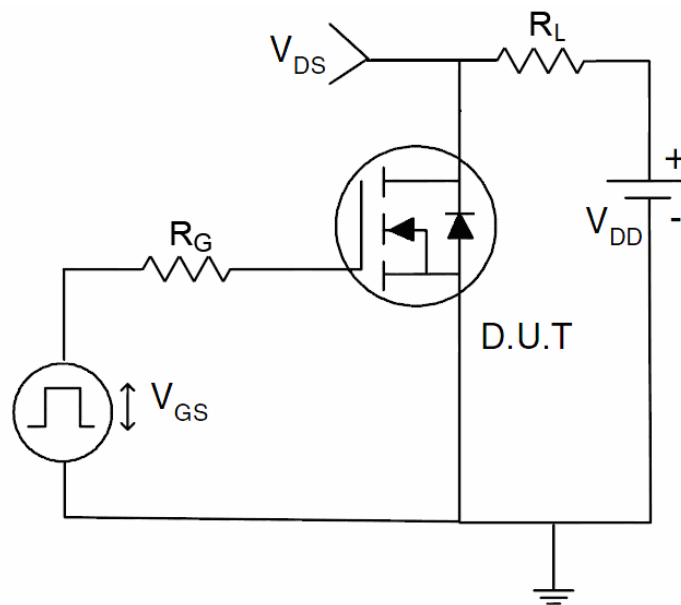

Typical Electrical and Thermal Characteristics (Curves)

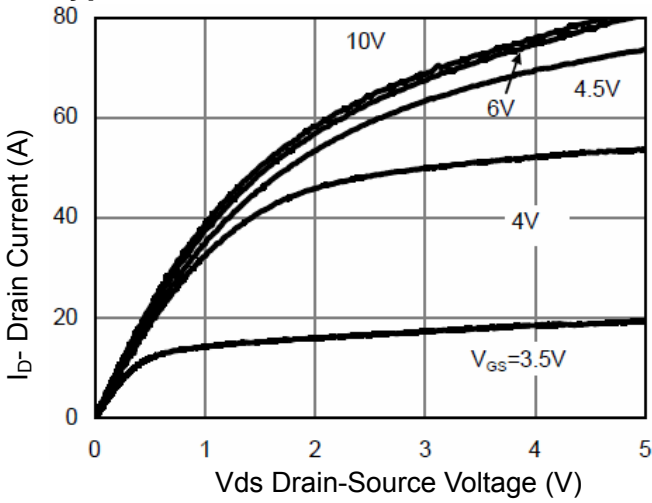

Figure 1 Output Characteristics

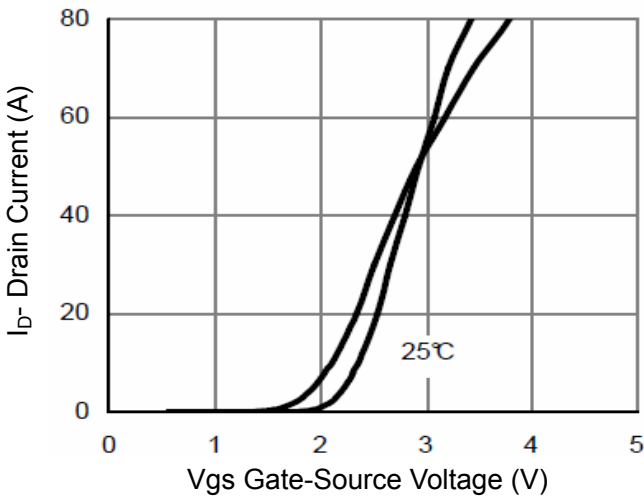

Figure 2 Transfer Characteristics

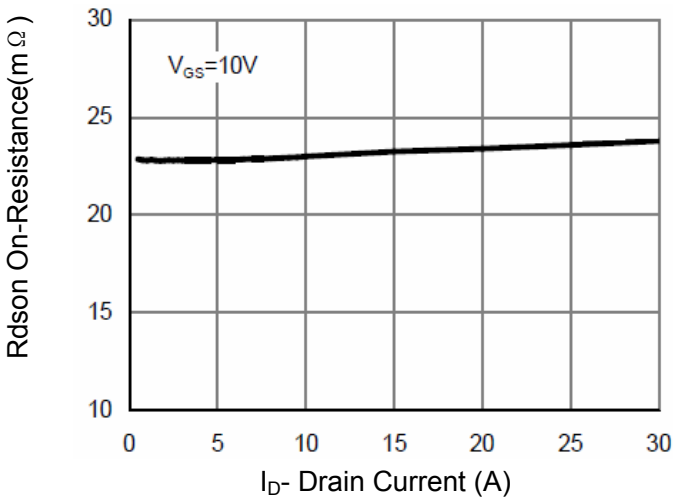

Figure 3 Rdson- Drain Current

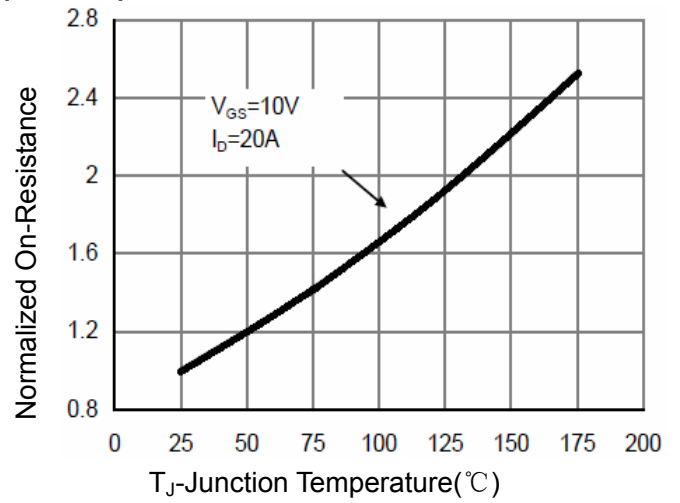

Figure 4 Rdson-Junction Temperature

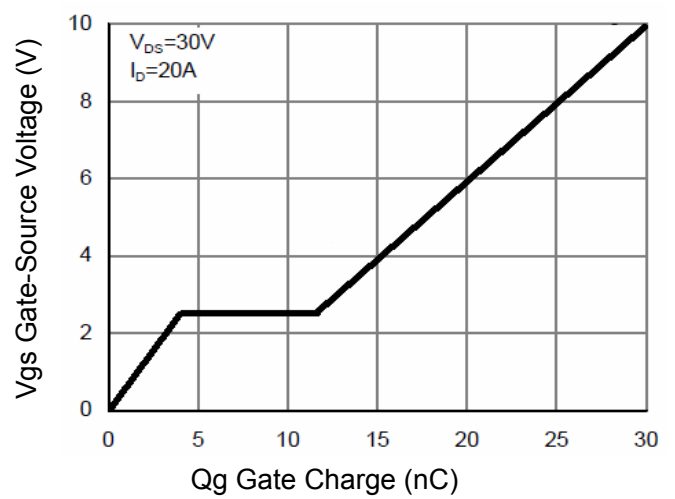

Figure 5 Gate Charge

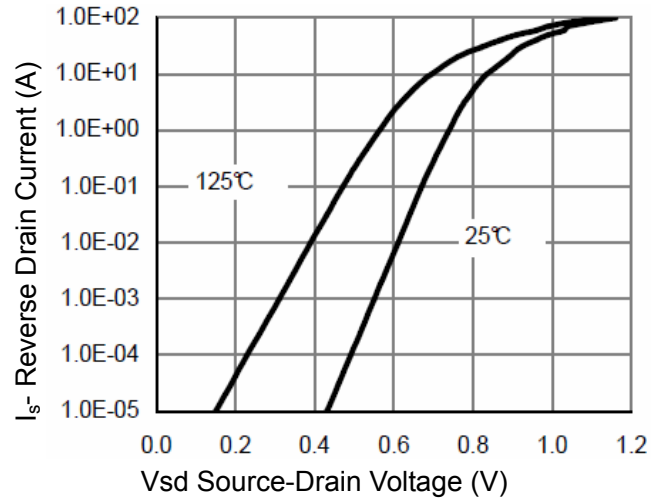

Figure 6 Source- Drain Diode Forward

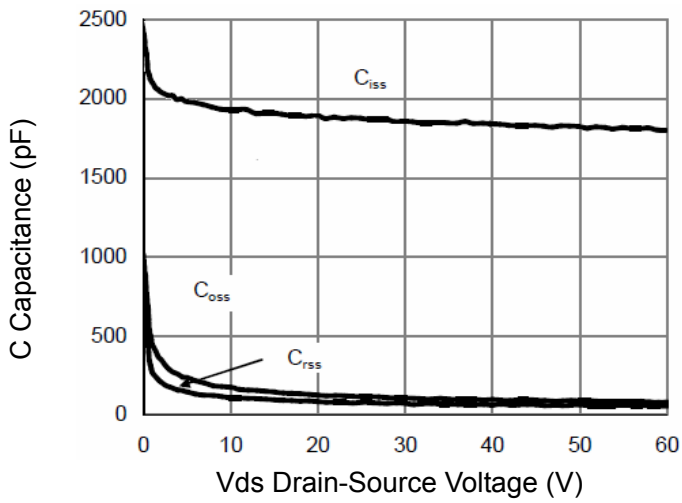

Figure 7 Capacitance vs Vds

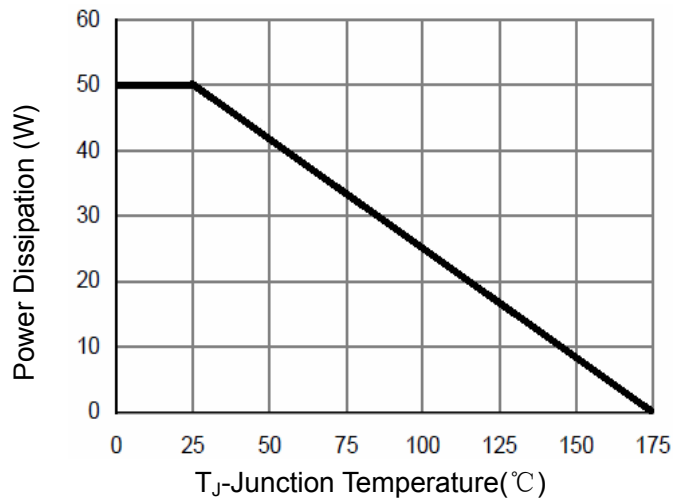

Figure 9 Power De-rating

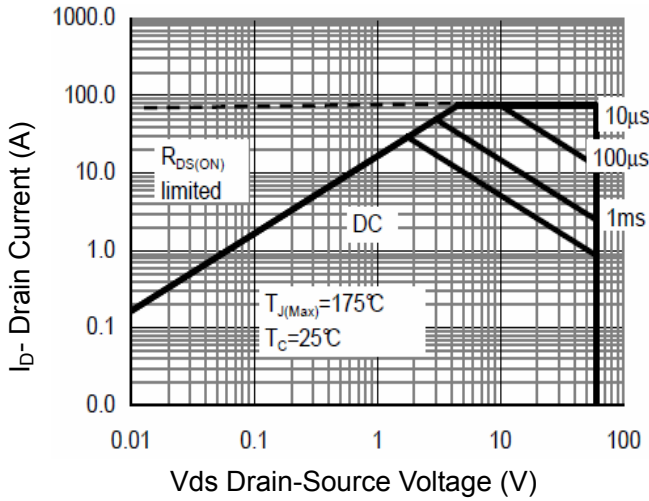

Figure 8 Safe Operation Area

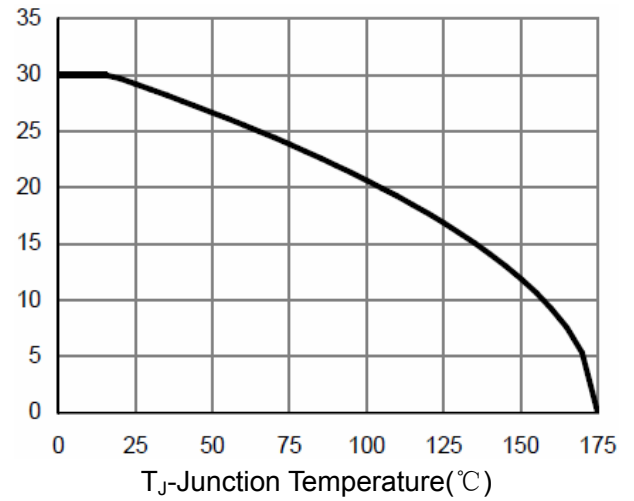

Figure 10 $V_{GS(th)}$ vs Junction Temperature

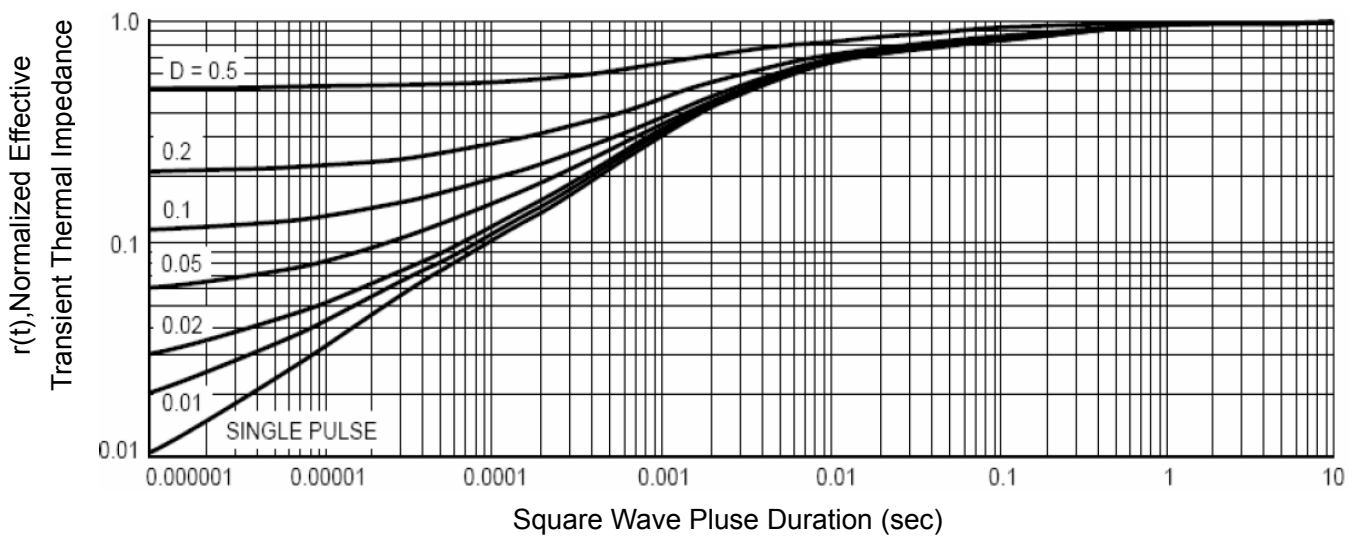
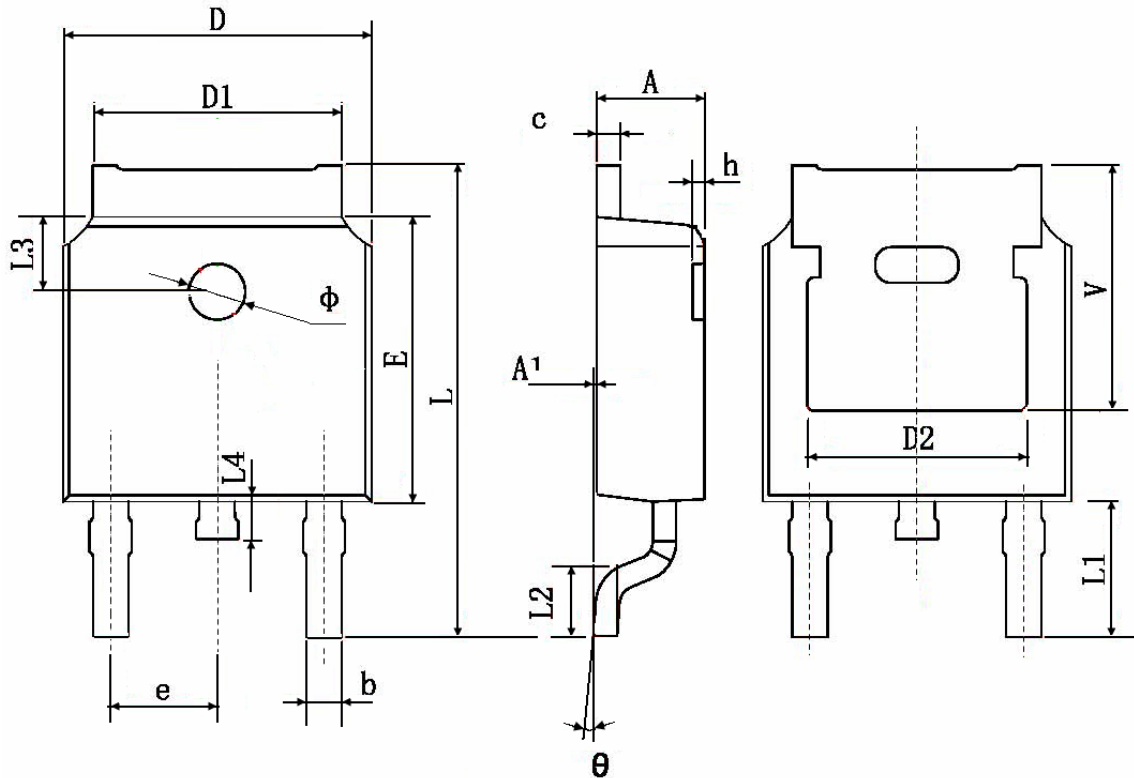

Figure 11 Normalized Maximum Transient Thermal Impedance

TO-252 Package Information



Symbol	Dimensions In Millimeters		Dimensions In Inches	
	Min.	Max.	Min.	Max.
A	2.200	2.400	0.087	0.094
A1	0.000	0.127	0.000	0.005
b	0.660	0.860	0.026	0.034
c	0.460	0.580	0.018	0.023
D	6.500	6.700	0.256	0.264
D1	5.100	5.460	0.201	0.215
D2	4.830 TYP.		0.190 TYP.	
E	6.000	6.200	0.236	0.244
e	2.186	2.386	0.086	0.094
L	9.800	10.400	0.386	0.409
L1	2.900 TYP.		0.114 TYP.	
L2	1.400	1.700	0.055	0.067
L3	1.600 TYP.		0.063 TYP.	
L4	0.600	1.000	0.024	0.039
Φ	1.100	1.300	0.043	0.051
θ	0°	8°	0°	8°
h	0.000	0.300	0.000	0.012
V	5.350 TYP.		0.211 TYP.	

Attention

QIAOXIN assumes no responsibility for equipment failures that result from using products at values that exceed, even momentarily, rated values (such as maximum ratings, operating condition ranges, or other parameters) listed in products specifications of any and all QIAOXIN products described or contained herein. QIAOXIN products are not designed for use in life support appliances, devices or systems where malfunction of these products can be reasonably expected to result in personal injury. Reproduction in whole or in part is prohibited without the prior written consent of the copyright owner. QIAOXIN reserves the right to make changes to information published in this document, including without limitation specifications and product descriptions, at any time and without notice. This document supersedes and replaces all information supplied prior to the publication hereof.