

**NCE N-Channel Enhancement Mode Power MOSFET**

**Description**

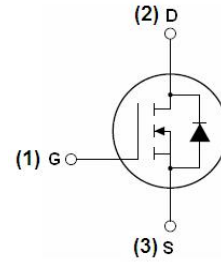
The VCRR6080K uses advanced trench technology and design to provide excellent  $R_{DS(ON)}$  with low gate charge. It can be used in a wide variety of applications.

**General Features**

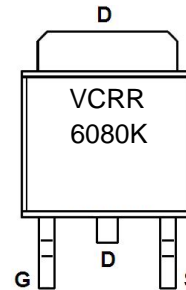
- $V_{DS} = 60V, I_D = 80A$   
 $R_{DS(ON)} < 7m\Omega @ V_{GS} = 10V$
- High density cell design for ultra low  $R_{dson}$
- Fully characterized avalanche voltage and current
- Good stability and uniformity with high  $E_{AS}$
- Excellent package for good heat dissipation

**Application**

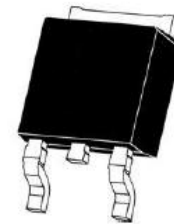
- PWM
- Load Switching



Schematic diagram



Marking and pin assignment



TO-252-2L top view

**Package Marking and Ordering Information**

Device Marking	Device	Device Package
VCRR6080K		TO-252-2L

**Absolute Maximum Ratings ( $T_c = 25^\circ C$  unless otherwise noted)**

Parameter	Symbol	Limit	Unit
Drain-Source Voltage	$V_{DS}$	60	V
Gate-Source Voltage	$V_{GS}$	$\pm 20$	V
Drain Current-Continuous	$I_D$	80	A
Drain Current-Continuous( $T_c = 100^\circ C$ )	$I_D(100^\circ C)$	56.5	A
Pulsed Drain Current	$I_{DM}$	320	A
Maximum Power Dissipation	$P_D$	110	W
Derating factor		0.73	W/ $^\circ C$
Single pulse avalanche energy <sup>(Note 5)</sup>	$E_{AS}$	390	mJ
Operating Junction and Storage Temperature Range	$T_J, T_{STG}$	-55 To 175	$^\circ C$

## Thermal Characteristic

Thermal Resistance, Junction-to-Case <sup>(Note 2)</sup>	$R_{\theta JC}$	1.36	$^{\circ}C/W$
Thermal Resistance, Junction-to-Ambient <sup>(Note 2)</sup>	$R_{\theta JA}$	60	$^{\circ}C/W$

## Electrical Characteristics ( $T_C=25^{\circ}C$ unless otherwise noted)

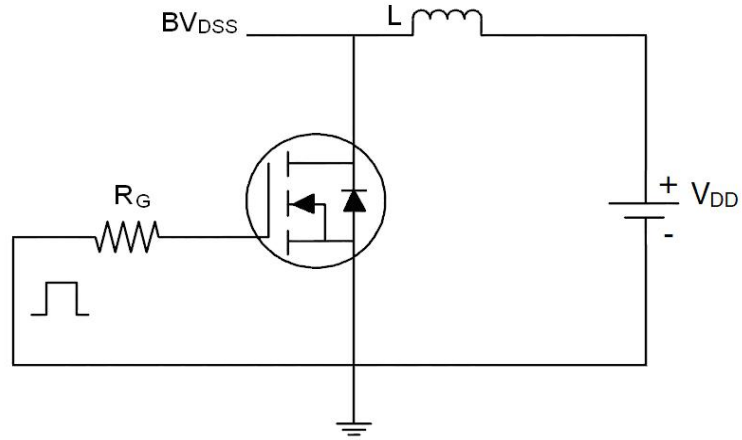
Parameter	Symbol	Condition	Min	Typ	Max	Unit
<b>Off Characteristics</b>						
Drain-Source Breakdown Voltage	$BV_{DSS}$	$V_{GS}=0V, I_D=250\mu A$	60	-	-	V
Zero Gate Voltage Drain Current	$I_{DSS}$	$V_{DS}=60V, V_{GS}=0V$	-	-	1	$\mu A$
Gate-Body Leakage Current	$I_{GSS}$	$V_{GS}=\pm 20V, V_{DS}=0V$	-	-	$\pm 100$	nA
<b>On Characteristics</b> <sup>(Note 3)</sup>						
Gate Threshold Voltage	$V_{GS(th)}$	$V_{DS}=V_{GS}, I_D=250\mu A$	2	2.8	4	V
Drain-Source On-State Resistance	$R_{DS(on)}$	$V_{GS}=10V, I_D=20A$	-	6	7	m $\Omega$
Forward Transconductance	$g_{FS}$	$V_{DS}=5V, I_D=20A$	20	-	-	S
<b>Dynamic Characteristics</b> <sup>(Note 4)</sup>						
Input Capacitance	$C_{iss}$	$V_{DS}=30V, V_{GS}=0V,$ $F=1.0MHz$	-	4000	-	PF
Output Capacitance	$C_{oss}$		-	290	-	PF
Reverse Transfer Capacitance	$C_{rss}$		-	210	-	PF
<b>Switching Characteristics</b> <sup>(Note 4)</sup>						
Turn-on Delay Time	$t_{d(on)}$	$V_{DD}=30V, R_L=1\Omega$ $V_{GS}=10V, R_G=3\Omega$	-	8.5	-	nS
Turn-on Rise Time	$t_r$		-	7	-	nS
Turn-Off Delay Time	$t_{d(off)}$		-	40	-	nS
Turn-Off Fall Time	$t_f$		-	15	-	nS
Total Gate Charge	$Q_g$	$V_{DS}=30V, I_D=20A,$ $V_{GS}=10V$	-	90	-	nC
Gate-Source Charge	$Q_{gs}$		-	9	-	nC
Gate-Drain Charge	$Q_{gd}$		-	18	-	nC
<b>Drain-Source Diode Characteristics</b>						
Diode Forward Voltage <sup>(Note 3)</sup>	$V_{SD}$	$V_{GS}=0V, I_S=20A$	-	-	1.2	V
Diode Forward Current <sup>(Note 2)</sup>	$I_S$		-	-	80	A
Reverse Recovery Time	$t_{rr}$	$T_J = 25^{\circ}C, I_F = 20A$ $di/dt = 100A/\mu s$ <sup>(Note 3)</sup>	-	32	-	nS
Reverse Recovery Charge	$Q_{rr}$		-	45	-	nC
Forward Turn-On Time	$t_{on}$	Intrinsic turn-on time is negligible (turn-on is dominated by LS+LD)				

### Notes:

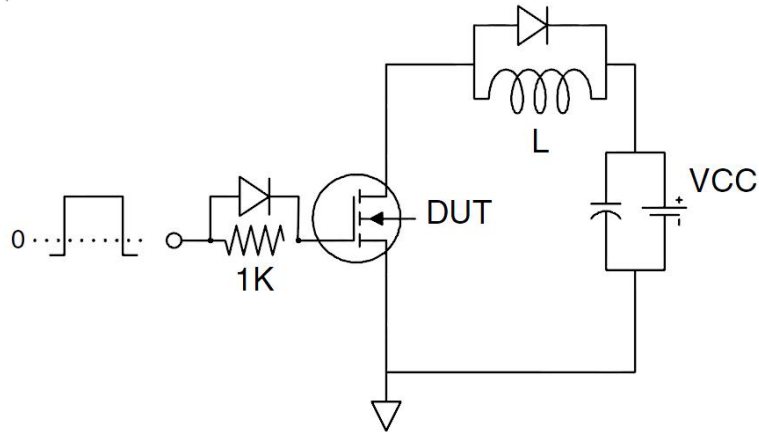
1. Repetitive Rating: Pulse width limited by maximum junction temperature.
2. Surface Mounted on FR4 Board,  $t \leq 10$  sec.
3. Pulse Test: Pulse Width  $\leq 300\mu s$ , Duty Cycle  $\leq 2\%$ .
4. Guaranteed by design, not subject to production
5.  $E_{AS}$  condition :  $T_J=25^{\circ}C, V_{DD}=20V, V_G=10V, L=0.5mH, R_G=25\Omega$

**Test circuit**

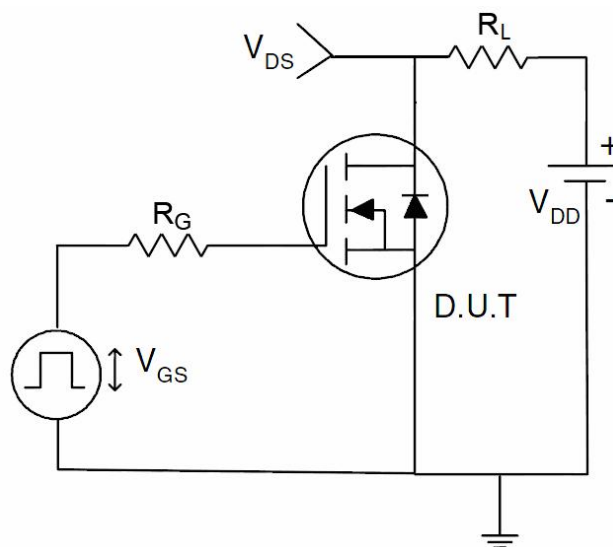
**1)  $E_{AS}$  Test Circuit**



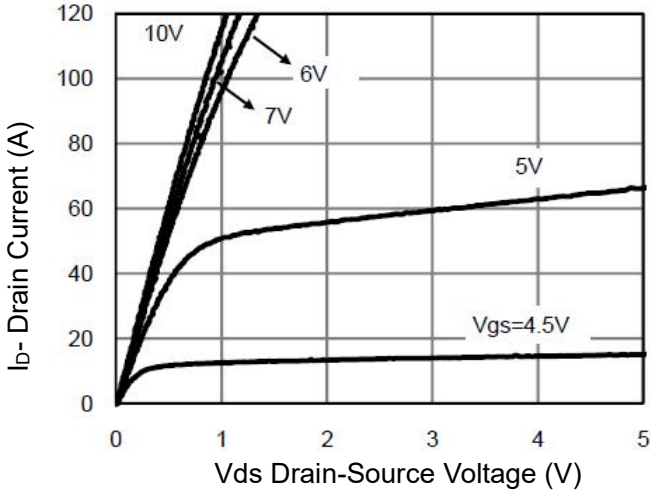
**2) Gate Charge Test Circuit**



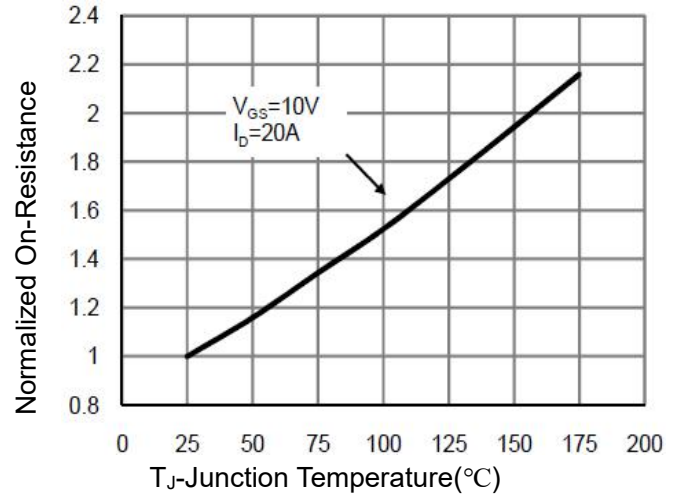
**3) Switch Time Test Circuit**



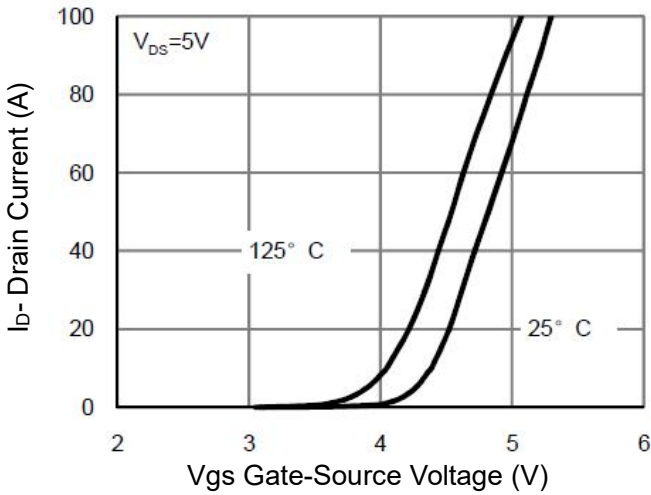
**Typical Electrical and Thermal Characteristics (Curves)**



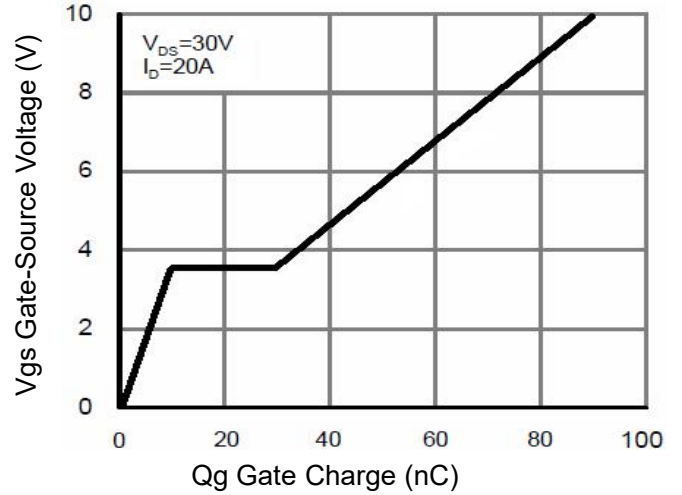
**Figure 1 Output Characteristics**



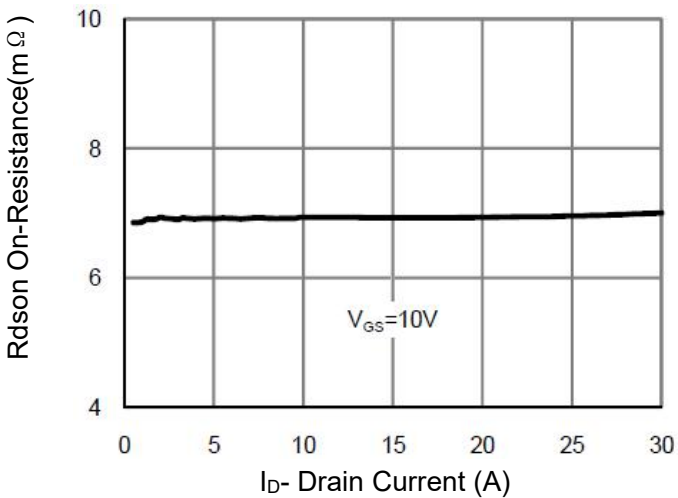
**Figure 4 Rds(on)-Junction Temperature**



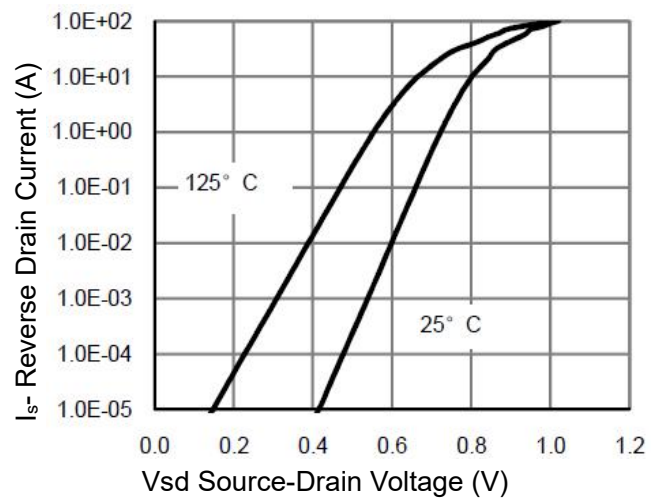
**Figure 2 Transfer Characteristics**



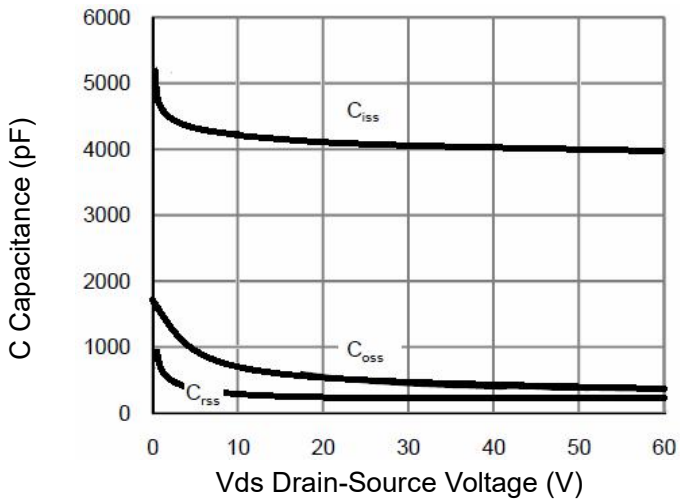
**Figure 5 Gate Charge**



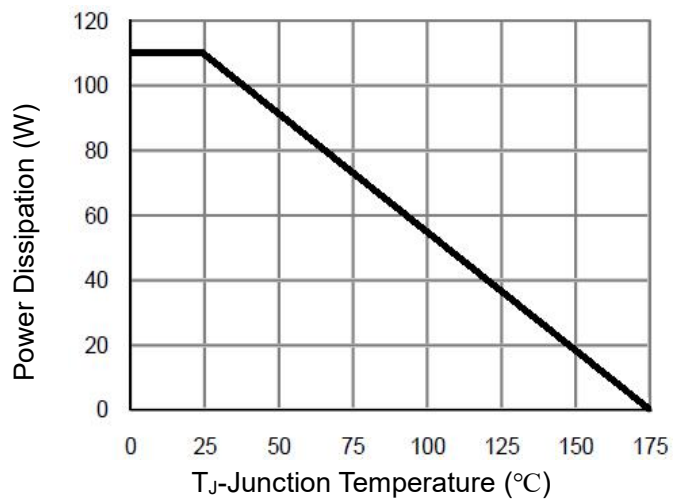
**Figure 3 Rds(on)- Drain Current**



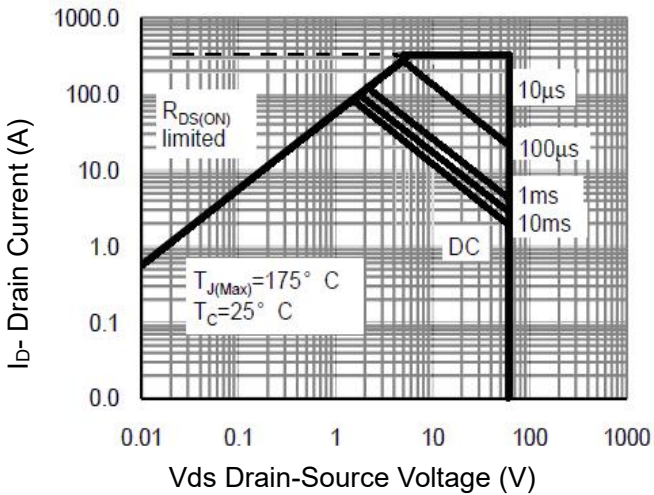
**Figure 6 Source- Drain Diode Forward**



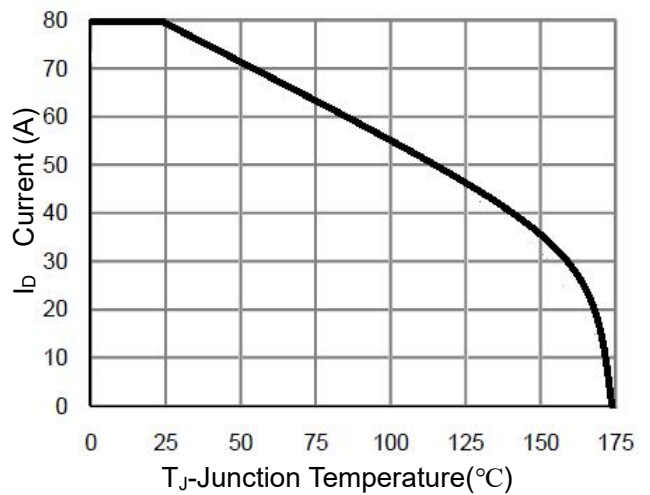
**Figure 7 Capacitance vs Vds**



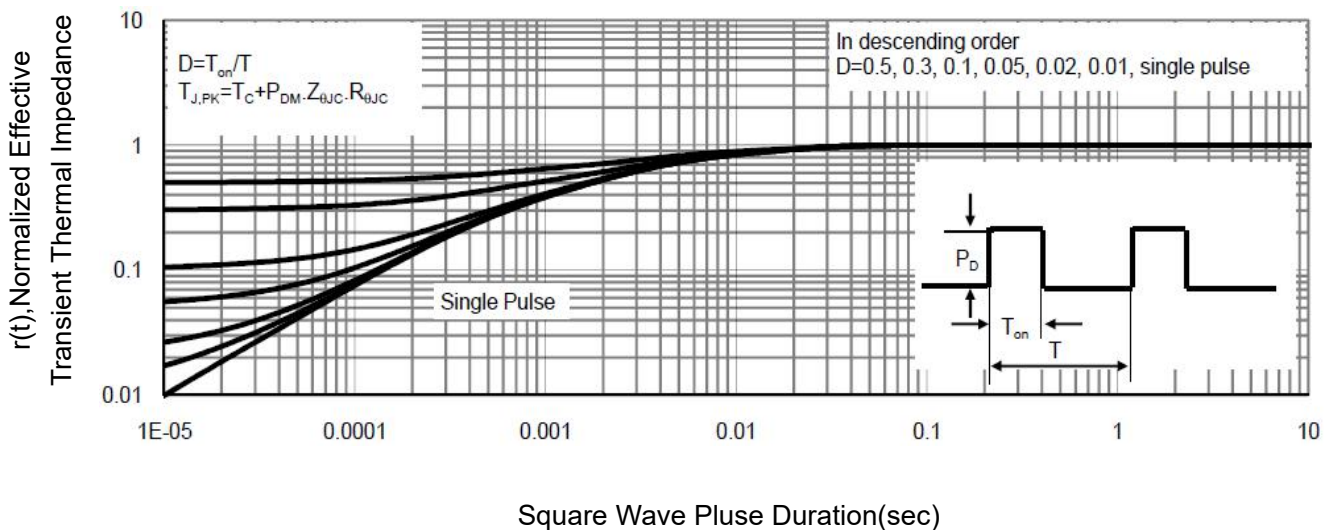
**Figure 9 Power De-rating**



**Figure 8 Safe Operation Area**

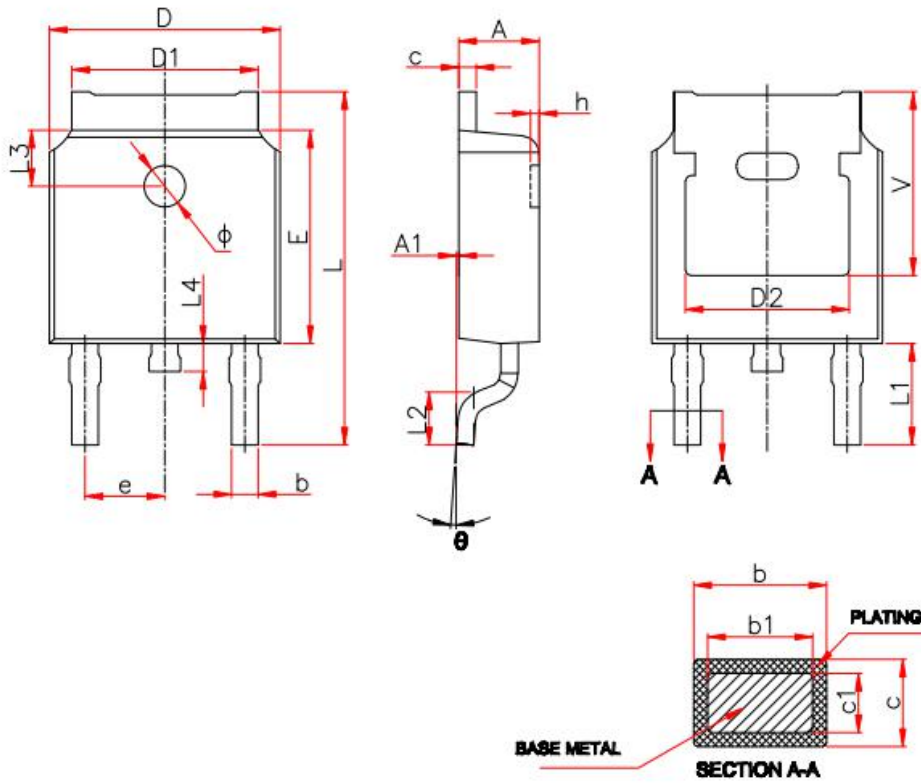


**Figure 10 ID Current- Junction Temperature**



**Figure 11 Normalized Maximum Transient Thermal Impedance**

**TO-252 Package Information**



Symbol	Millimeters	
	Min.	Max.
A	2.20	2.40
A1	0.00	0.13
b	0.66	0.86
b1	0.73	0.79
c	0.46	0.58
c1	0.50	0.52
D	6.50	6.70
D1	5.10	5.46
D2	4.83 REF.	
E	6.00	6.20
e	2.19	2.39
L	9.80	10.40
L1	2.90 REF.	
L2	1.40	1.70
L3	1.60 REF.	
L4	0.60	1.00
φ	1.10	1.30
θ	0°	8°

## Attention

QIAOXIN assumes no responsibility for equipment failures that result from using products at values that exceed, even momentarily, rated values (such as maximum ratings, operating condition ranges, or other parameters) listed in products specifications of any and all QIAOXIN products described or contained herein. QIAOXIN products are not designed for use in life support appliances, devices or systems where malfunction of these products can be reasonably expected to result in personal injury. Reproduction in whole or in part is prohibited without the prior written consent of the copyright owner. QIAOXIN reserves the right to make changes to information published in this document, including without limitation specifications and product descriptions, at any time and without notice. This document supersedes and replaces all information supplied prior to the publication hereof.