

NCE N-Channel Super Trench Power MOSFET

Description

The VCRR0178D uses **Super Trench** technology that is uniquely optimized to provide the most efficient high frequency switching performance. Both conduction and switching power losses are minimized due to an extremely low combination of $R_{DS(ON)}$ and Q_g . This device is ideal for high-frequency switching and synchronous rectification.

General Features

- $V_{DS} = 100V, I_D = 78A$
 $R_{DS(ON)} < 8.5m\Omega @ V_{GS} = 10V$
- Excellent gate charge x $R_{DS(on)}$ product(FOM)
- Very low on-resistance $R_{DS(on)}$
- 175 °C operating temperature
- Pb-free lead plating
- 100% UIS tested

Application

- DC/DC Converter
- Ideal for high-frequency switching and synchronous rectification

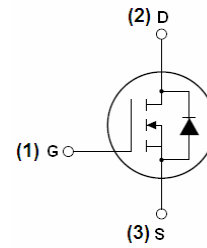

Schematic diagram

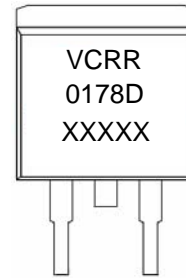

Marking and pin assignment



TO-263-2L top view

Package Marking and Ordering Information

Device Marking	Device	Device Package
VCRR0178D		TO-220-3L

Absolute Maximum Ratings ($T_C=25^\circ C$ unless otherwise noted)

Parameter	Symbol	Limit	Unit
Drain-Source Voltage	V_{DS}	100	V
Gate-Source Voltage	V_{GS}	± 20	V
Drain Current-Continuous	I_D	78	A
Drain Current-Continuous($T_C=100^\circ C$)	$I_D(100^\circ C)$	60	A
Pulsed Drain Current	I_{DM}	320	A
Maximum Power Dissipation	P_D	125	W
Derating factor		0.83	W/ $^\circ C$
Single pulse avalanche energy ^(Note 5)	E_{AS}	210	mJ
Operating Junction and Storage Temperature Range	T_J, T_{STG}	-55 To 175	$^\circ C$

Thermal Characteristic

Thermal Resistance, Junction-to-Case ^(Note 2)	$R_{\theta JC}$	1.2	$^{\circ}C/W$
--	-----------------	-----	---------------

Electrical Characteristics ($T_C=25^{\circ}C$ unless otherwise noted)

Parameter	Symbol	Condition	Min	Typ	Max	Unit
Off Characteristics						
Drain-Source Breakdown Voltage	BV_{DSS}	$V_{GS}=0V, I_D=250\mu A$	100		-	V
Zero Gate Voltage Drain Current	I_{DSS}	$V_{DS}=100V, V_{GS}=0V$	-	-	1	μA
Gate-Body Leakage Current	I_{GSS}	$V_{GS}=\pm 20V, V_{DS}=0V$	-	-	± 100	nA
On Characteristics ^(Note 3)						
Gate Threshold Voltage	$V_{GS(th)}$	$V_{DS}=V_{GS}, I_D=250\mu A$	2.5	3.5	4.5	V
Drain-Source On-State Resistance	$R_{DS(ON)}$	$V_{GS}=10V, I_D=39A$	-	7.2	8.5	m Ω
Forward Transconductance	g_{FS}	$V_{DS}=10V, I_D=39A$	40	-	-	S
Dynamic Characteristics ^(Note 4)						
Input Capacitance	C_{iss}	$V_{DS}=50V, V_{GS}=0V,$ $F=1.0MHz$	-	3500	-	PF
Output Capacitance	C_{oss}		-	600	-	PF
Reverse Transfer Capacitance	C_{rss}		-	29	-	PF
Switching Characteristics ^(Note 4)						
Turn-on Delay Time	$t_{d(on)}$	$V_{DD}=50V, I_D=39A$ $V_{GS}=10V, R_G=4.7\Omega$	-	12	-	nS
Turn-on Rise Time	t_r		-	45	-	nS
Turn-Off Delay Time	$t_{d(off)}$		-	31	-	nS
Turn-Off Fall Time	t_f		-	10	-	nS
Total Gate Charge	Q_g	$V_{DS}=50V, I_D=39A,$ $V_{GS}=10V$	-	48		nC
Gate-Source Charge	Q_{gs}		-	15		nC
Gate-Drain Charge	Q_{gd}		-	8		nC
Drain-Source Diode Characteristics						
Diode Forward Voltage ^(Note 3)	V_{SD}	$V_{GS}=0V, I_S=78A$	-		1.2	V
Diode Forward Current ^(Note 2)	I_S		-	-	78	A
Reverse Recovery Time	t_{rr}	$T_J = 25^{\circ}C, I_F = I_S$ $di/dt = 100A/\mu s$ ^(Note 3)	-	95		nS
Reverse Recovery Charge	Q_{rr}		-	110		nC

Notes:

1. Repetitive Rating: Pulse width limited by maximum junction temperature.
2. Surface Mounted on FR4 Board, $t \leq 10$ sec.
3. Pulse Test: Pulse Width $\leq 300\mu s$, Duty Cycle $\leq 2\%$.
4. Guaranteed by design, not subject to production
5. EAS condition : $T_J=25^{\circ}C, V_{DD}=50V, V_G=10V, L=0.5mH, R_G=25\Omega$

Test Circuit

1) E_{AS} test Circuit

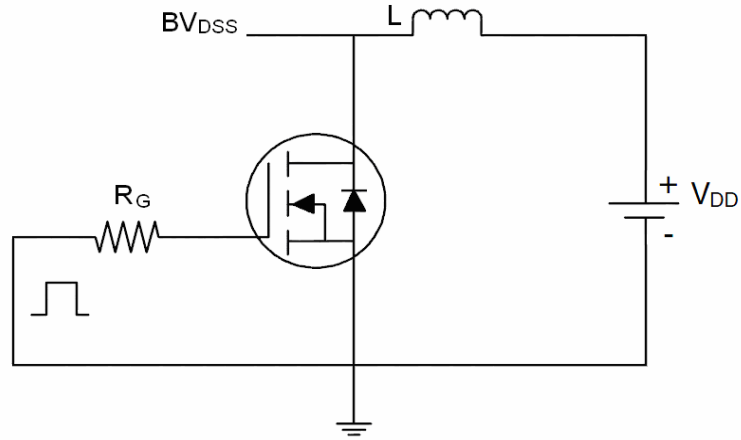

2) Gate charge test Circuit

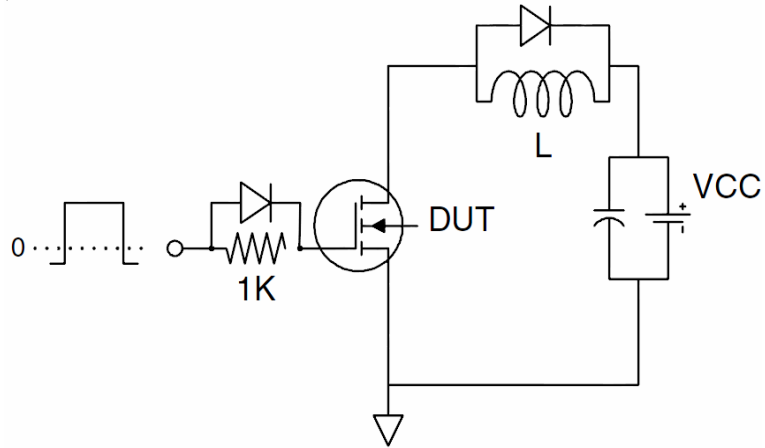

3) Switch Time Test Circuit

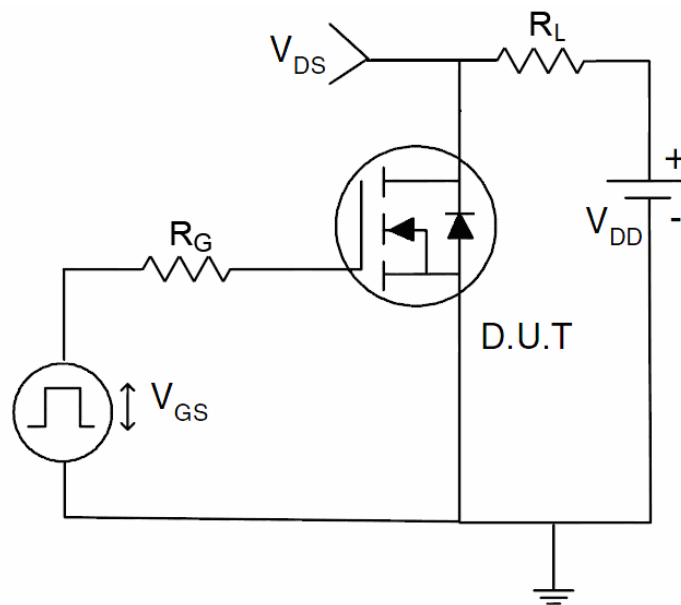

Typical Electrical and Thermal Characteristics

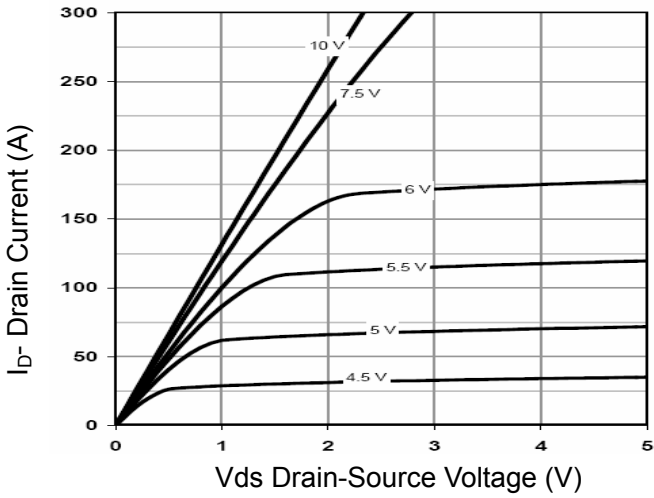

Figure 1 Output Characteristics

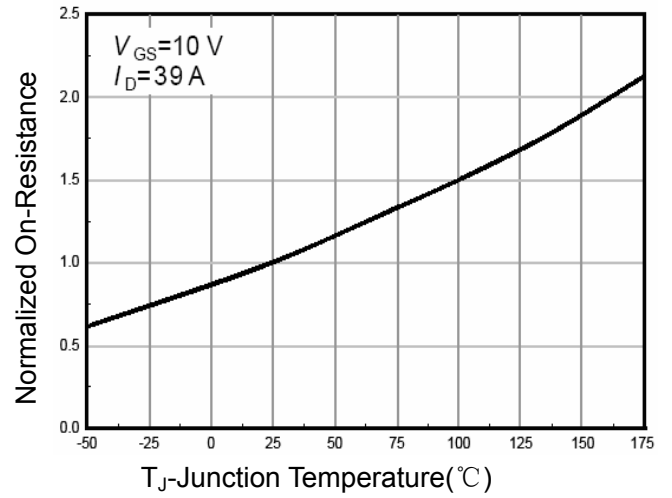

Figure 4 Rdson-Junction Temperature

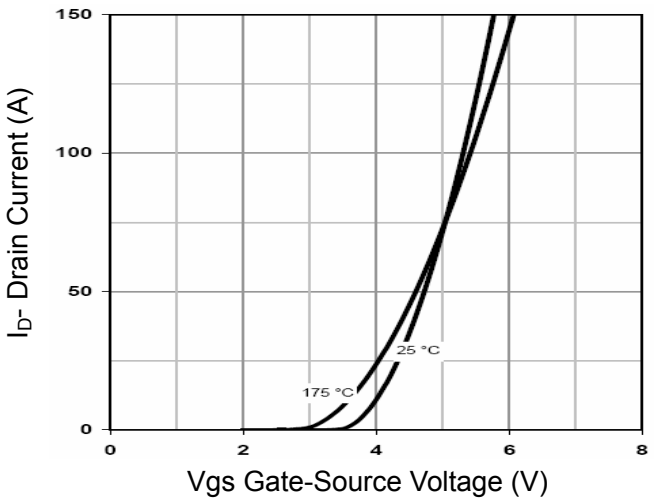

Figure 2 Transfer Characteristics

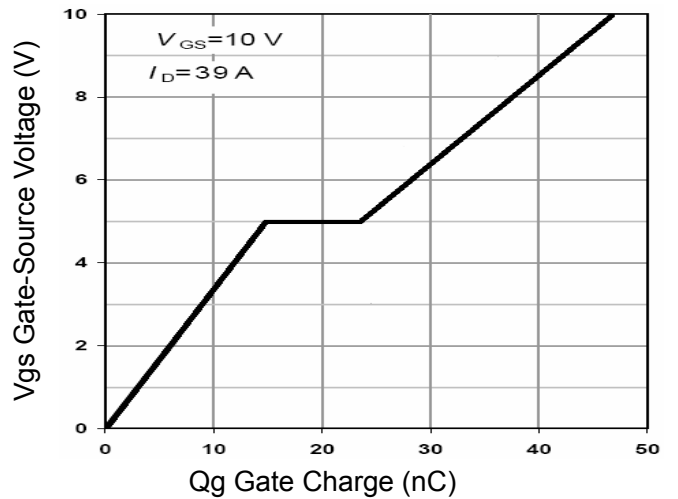

Figure 5 Gate Charge

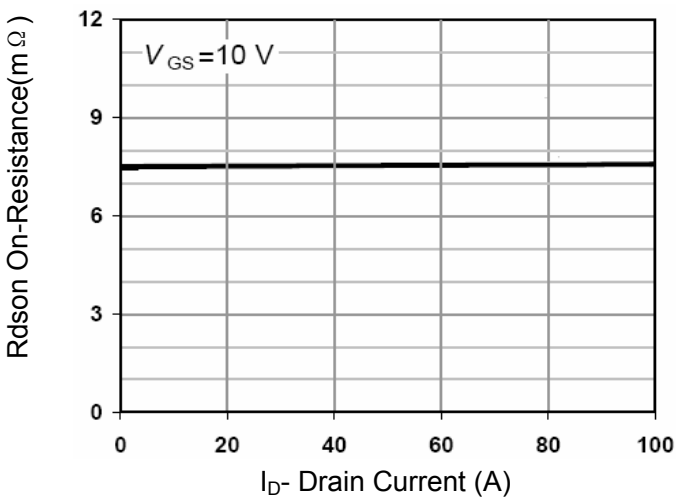

Figure 3 Rdson- Drain Current

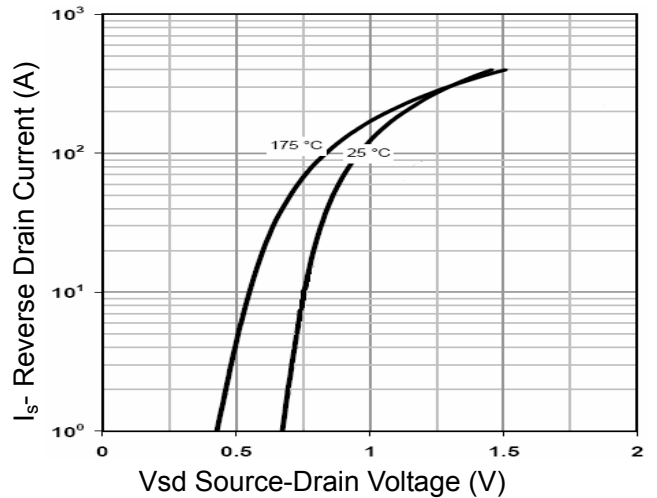

Figure 6 Source- Drain Diode Forward

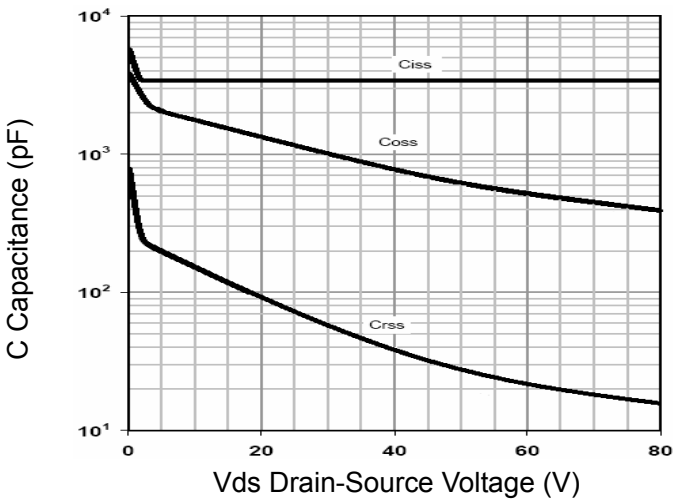

Figure 7 Capacitance vs Vds

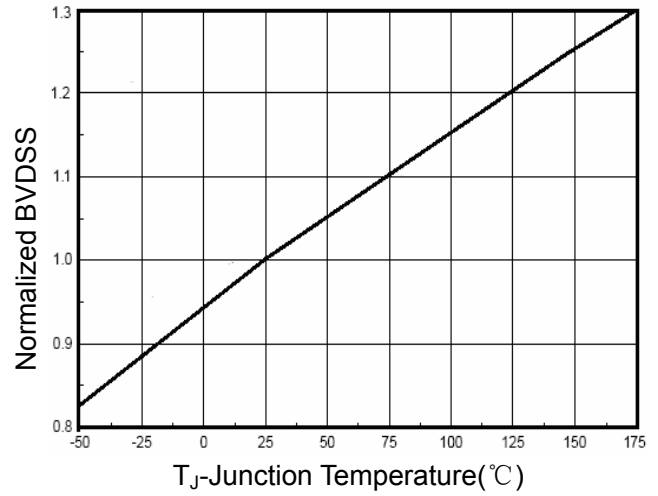

Figure 9 BV_{DSS} vs Junction Temperature

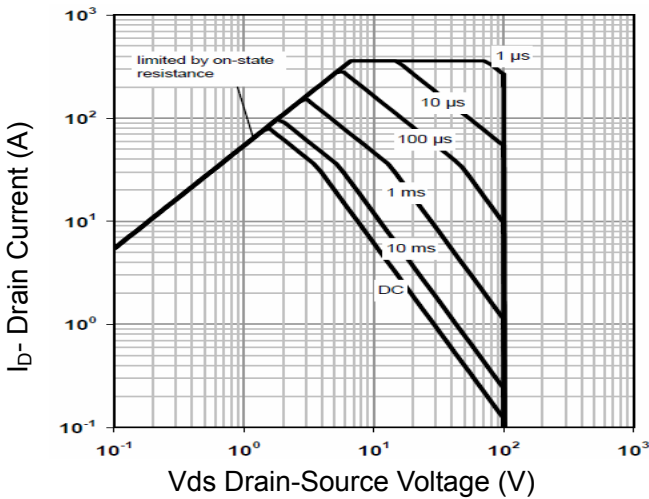

Figure 8 Safe Operation Area

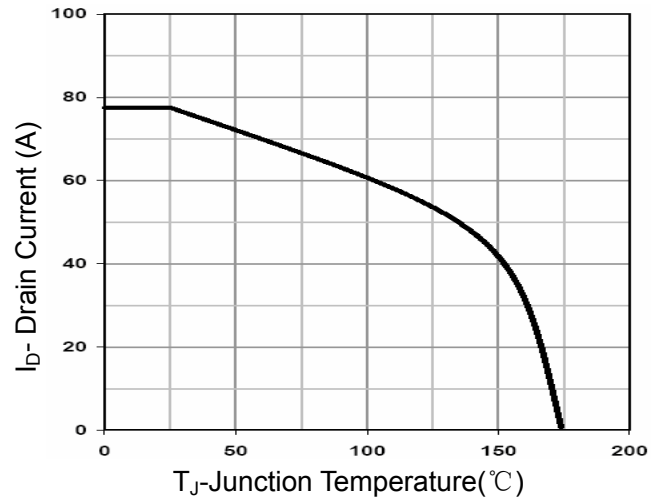

Figure 10 Current De-rating

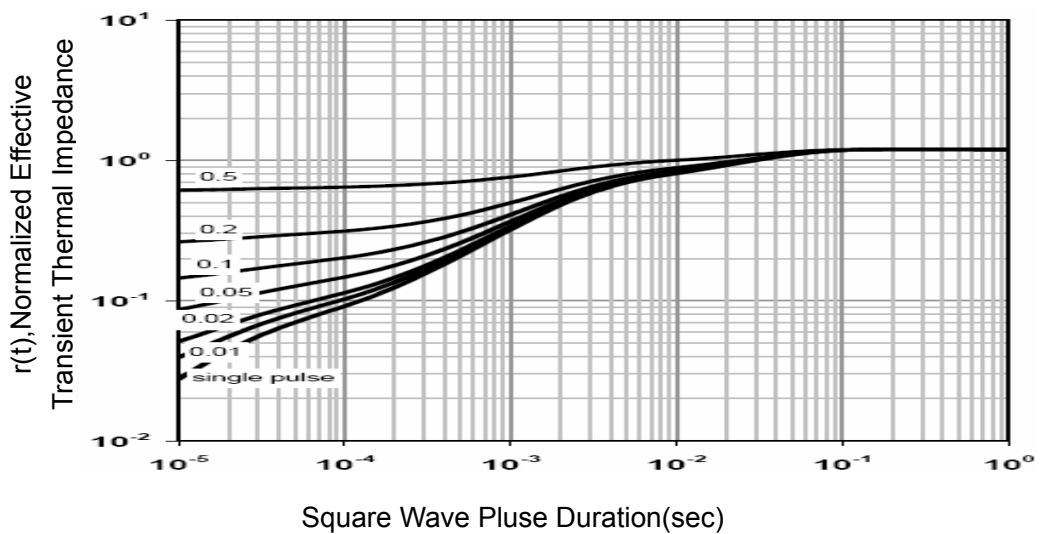
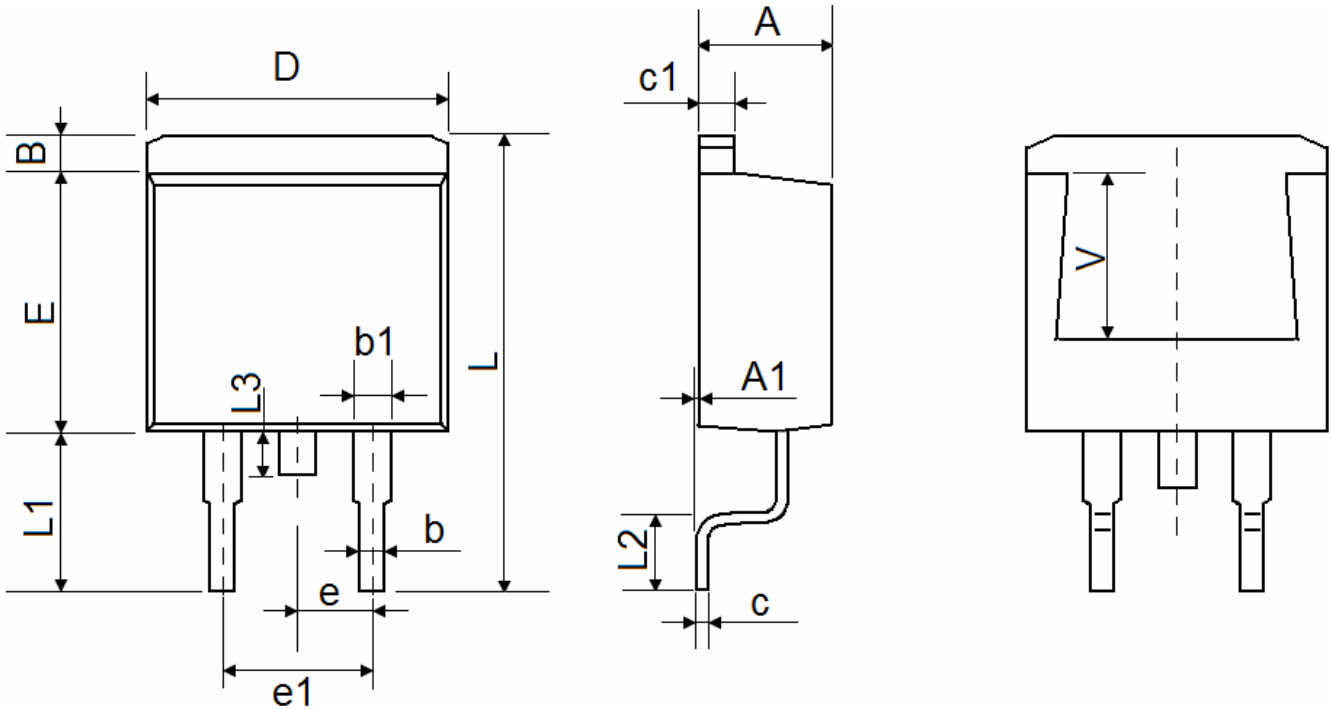

Figure 11 Normalized Maximum Transient Thermal Impedance

TO-263-2L Package Information



Symbol	Dimensions In Millimeters		Dimensions In Inches	
	Min.	Max.	Min.	Max.
A	4.470	4.670	0.176	0.184
A1	0.000	0.150	0.000	0.006
B	1.170	1.370	0.046	0.054
b	0.710	0.910	0.028	0.036
b1	1.170	1.370	0.046	0.054
c	0.310	0.530	0.012	0.021
c1	1.170	1.370	0.046	0.054
D	10.010	10.310	0.394	0.406
E	8.500	8.900	0.335	0.350
e	2.540 TYP.		0.100 TYP.	
e1	4.980	5.180	0.196	0.204
L	15.050	15.450	0.593	0.608
L1	5.080	5.480	0.200	0.216
L2	2.340	2.740	0.092	0.108
L3	1.300	1.700	0.051	0.067
V	5.600 REF		0.220 REF	

Attention

QIAOXIN assumes no responsibility for equipment failures that result from using products at values that exceed, even momentarily, rated values (such as maximum ratings, operating condition ranges, or other parameters) listed in products specifications of any and all QIAOXIN products described or contained herein. QIAOXIN products are not designed for use in life support appliances, devices or systems where malfunction of these products can be reasonably expected to result in personal injury. Reproduction in whole or in part is prohibited without the prior written consent of the copyright owner. QIAOXIN reserves the right to make changes to information published in this document, including without limitation specifications and product descriptions, at any time and without notice. This document supersedes and replaces all information supplied prior to the publication hereof.