

QIAOXIN N-Channel Super Trench II Power MOSFET

Description

The series of devices uses **Super Trench II** technology that is uniquely optimized to provide the most efficient high frequency switching performance. Both conduction and switching power losses are minimized due to an extremely low combination of $R_{DS(ON)}$ and Q_g . This device is ideal for high-frequency switching and synchronous rectification.

Application

- DC/DC Converter
- Ideal for high-frequency switching and synchronous rectification

General Features

- $V_{DS} = 85V, I_D = 95A$
 $R_{DS(ON)} = 5.4m\Omega$, typical (TO-220) @ $V_{GS} = 10V$
 $R_{DS(ON)} = 5.2m\Omega$, typical (TO-263) @ $V_{GS} = 10V$
- Excellent gate charge x $R_{DS(on)}$ product(FOM)
- Very low on-resistance $R_{DS(on)}$
- 175 °C operating temperature
- Pb-free lead plating

TO-220

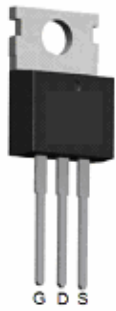

TO-263

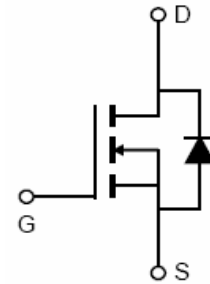
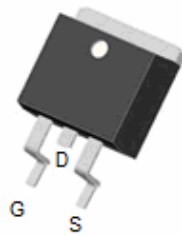

Schematic Diagram

Package Marking and Ordering Information

Device Marking	Device	Device Package	Reel Size	Tape width	Quantity
VCRR058N85	VCRR058N85	TO-220	-	-	-
VCRR058N85D	VCRR058N85D	TO-263	-	-	-

Absolute Maximum Ratings ($T_C = 25^\circ C$ unless otherwise noted)

Parameter	Symbol	Limit	Unit
Drain-Source Voltage	V_{DS}	85	V
Gate-Source Voltage	V_{GS}	± 20	V
Drain Current-Continuous	I_D	95	A
Drain Current-Continuous($T_C = 100^\circ C$)	$I_D(100^\circ C)$	70	A
Pulsed Drain Current	I_{DM}	380	A
Maximum Power Dissipation	P_D	125	W
Derating factor		0.83	W/°C
Single pulse avalanche energy ^(Note 5)	E_{AS}	599	mJ
Operating Junction and Storage Temperature Range	T_J, T_{STG}	-55 To 175	°C

Thermal Characteristic

Thermal Resistance, Junction-to-Case ^(Note 2)	$R_{\theta JC}$	1.2	$^{\circ}\text{C}/\text{W}$
Thermal Resistance, Junction-to-Ambient ^(Note 2)	$R_{\theta JA}$	60	$^{\circ}\text{C}/\text{W}$

Electrical Characteristics ($T_C=25^{\circ}\text{C}$ unless otherwise noted)

Parameter	Symbol	Condition	Min	Typ	Max	Unit	
Off Characteristics							
Drain-Source Breakdown Voltage	BV_{DSS}	$V_{GS}=0V, I_D=250\mu\text{A}$	85		-	V	
Zero Gate Voltage Drain Current	I_{DSS}	$V_{DS}=85V, V_{GS}=0V$	-	-	1	μA	
Gate-Body Leakage Current	I_{GSS}	$V_{GS}=\pm 20V, V_{DS}=0V$	-	-	± 100	nA	
On Characteristics ^(Note 3)							
Gate Threshold Voltage	$V_{GS(th)}$	$V_{DS}=V_{GS}, I_D=250\mu\text{A}$	2.0	3.0	4.0	V	
Drain-Source On-State Resistance	$R_{DS(on)}$	$V_{GS}=10V, I_D=45A$	TO-220	-	5.4	5.8	m Ω
			TO-263		5.2	5.8	m Ω
Forward Transconductance	g_{FS}	$V_{DS}=5V, I_D=45A$		60	-	S	
Dynamic Characteristics ^(Note 4)							
Input Capacitance	C_{iss}	$V_{DS}=40V, V_{GS}=0V,$ $F=1.0\text{MHz}$	-	3550	-	PF	
Output Capacitance	C_{oss}		-	540	-	PF	
Reverse Transfer Capacitance	C_{rss}		-	22	-	PF	
Switching Characteristics ^(Note 4)							
Turn-on Delay Time	$t_{d(on)}$	$V_{DD}=40V, I_D=45A$ $V_{GS}=10V, R_G=1.6\Omega$	-	14.5	-	nS	
Turn-on Rise Time	t_r		-	12	-	nS	
Turn-Off Delay Time	$t_{d(off)}$		-	35	-	nS	
Turn-Off Fall Time	t_f		-	13	-	nS	
Total Gate Charge	Q_g	$V_{DS}=40V, I_D=45A,$ $V_{GS}=10V$	-	67	-	nC	
Gate-Source Charge	Q_{gs}		-	20		nC	
Gate-Drain Charge	Q_{gd}		-	20		nC	
Drain-Source Diode Characteristics							
Diode Forward Voltage ^(Note 3)	V_{SD}	$V_{GS}=0V, I_S=45A$	-		1.2	V	
Diode Forward Current ^(Note 2)	I_S		-	-	95	A	
Reverse Recovery Time	t_{rr}	$T_J = 25^{\circ}\text{C}, I_F = I_S$	-	66	-	nS	
Reverse Recovery Charge	Q_{rr}	$di/dt = 100A/\mu\text{s}$ ^(Note 3)	-	140	-	nC	

Notes:

1. Repetitive Rating: Pulse width limited by maximum junction temperature.
2. The value of $R_{\theta JA}$ is measured with the device mounted on 1in2 FR-4 board with 2oz. Copper, in a still air environment with $T_A = 25^{\circ}\text{C}$. The Power dissipation P_{DSM} is based on $R_{\theta JA}$ and the maximum allowed junction temperature of 150°C . The value in any given application depends on the user's specific board design, and the maximum temperature of 175°C may be used if the PCB allows it.
3. Pulse Test: Pulse Width $\leq 300\mu\text{s}$, Duty Cycle $\leq 2\%$.
4. Guaranteed by design, not subject to production
5. EAS condition : $T_J=25^{\circ}\text{C}, V_{DD}=40V, V_G=10V, L=0.5\text{mH}, R_G=25\Omega$

Typical Electrical and Thermal Characteristics

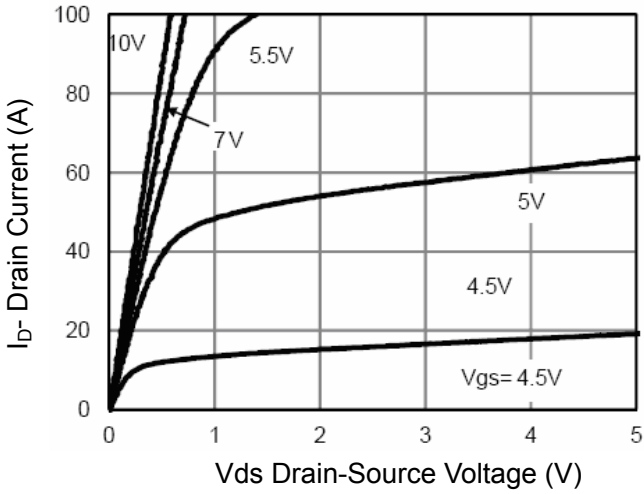

Figure 1 Output Characteristics

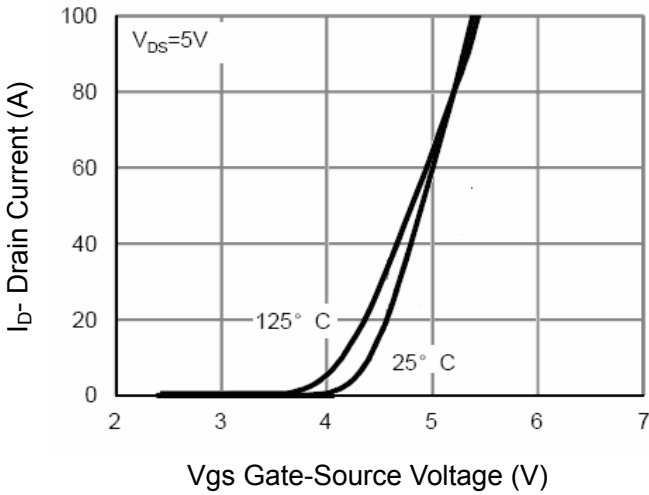

Figure 2 Transfer Characteristics

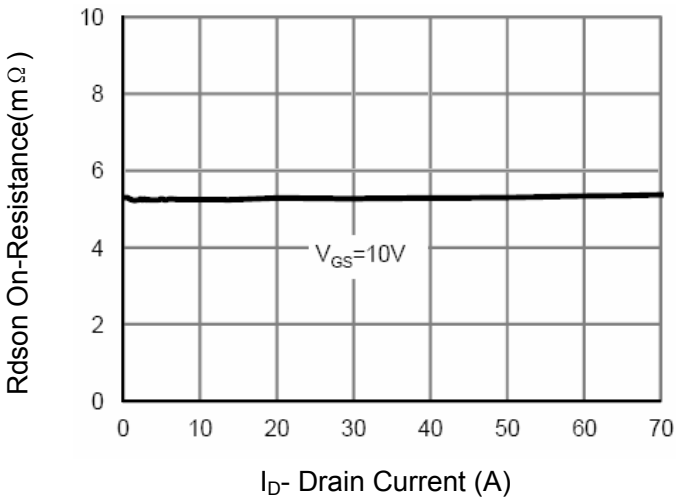

Figure 3 Rdson- Drain Current

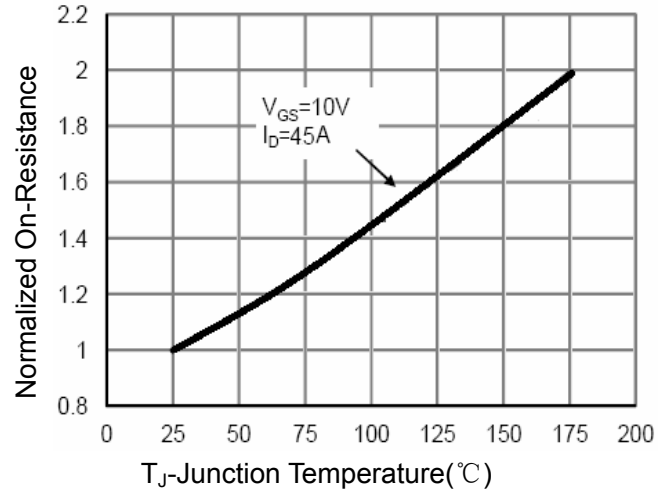

Figure 4 Rdson-Junction Temperature

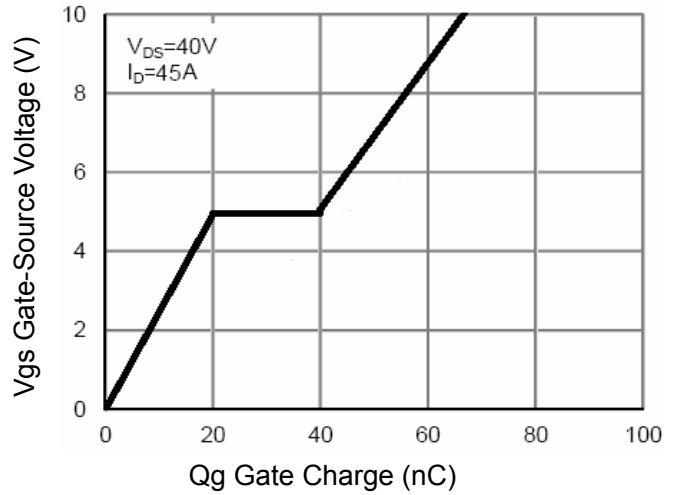

Figure 5 Gate Charge

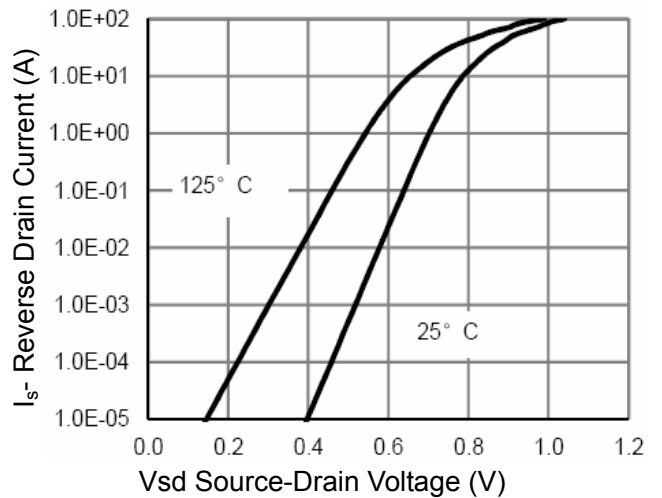

Figure 6 Source- Drain Diode Forward

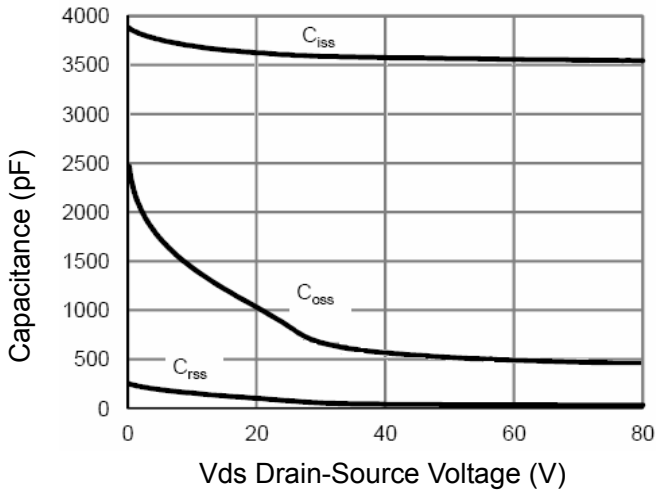

Figure 7 Capacitance vs Vds

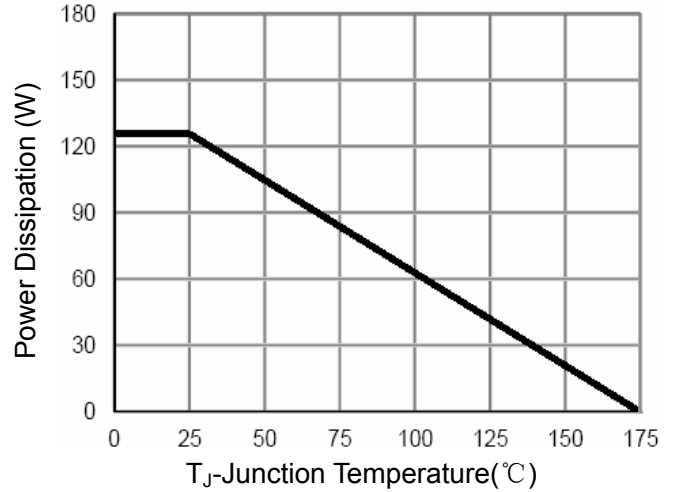

Figure 9 Power De-rating

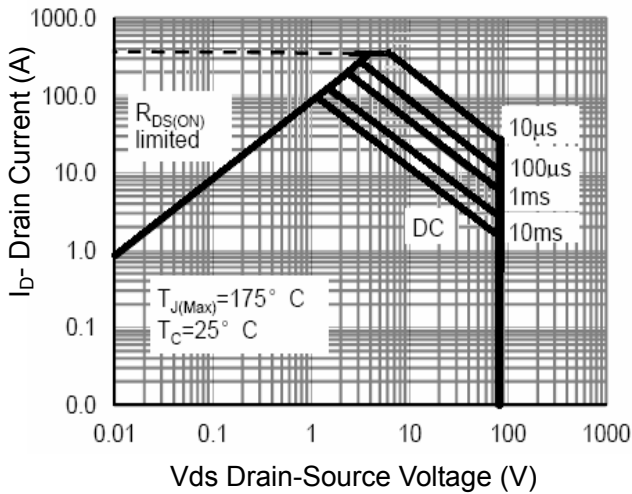

Figure 8 Safe Operation Area

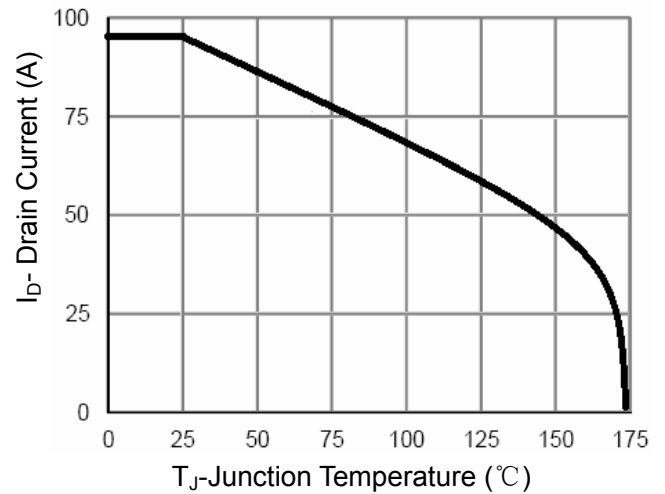

Figure 10 Current De-rating

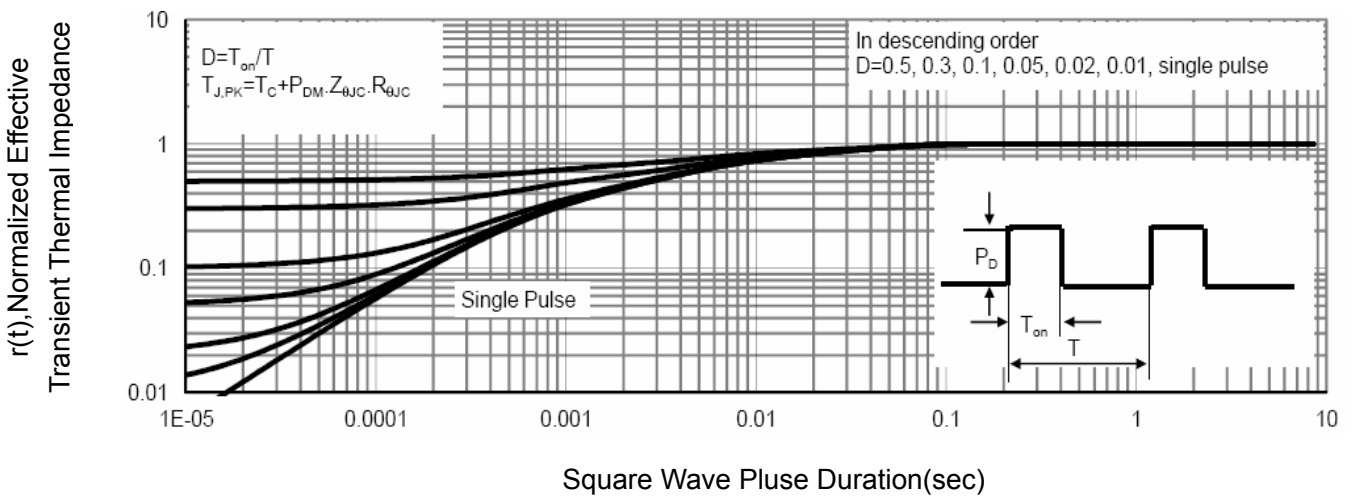

Figure 11 Normalized Maximum Transient Thermal Impedance

TO-220-3L Package Information



Symbol	Dimensions In Millimeters		Dimensions In Inches	
	Min.	Max.	Min.	Max.
A	4.400	4.600	0.173	0.181
A1	2.250	2.550	0.089	0.100
b	0.710	0.910	0.028	0.036
b1	1.170	1.370	0.046	0.054
c	0.330	0.650	0.013	0.026
c1	1.200	1.400	0.047	0.055
D	9.910	10.250	0.390	0.404
E	8.9500	9.750	0.352	0.384
E1	12.650	12.950	0.498	0.510
e	2.540 TYP.		0.100 TYP.	
e1	4.980	5.180	0.196	0.204
F	2.650	2.950	0.104	0.116
H	7.900	8.100	0.311	0.319
h	0.000	0.300	0.000	0.012
L	12.900	13.400	0.508	0.528
L1	2.850	3.250	0.112	0.128
V	7.500 REF.		0.295 REF.	
Φ	3.400	3.800	0.134	0.150

TO-263-2L Package Information

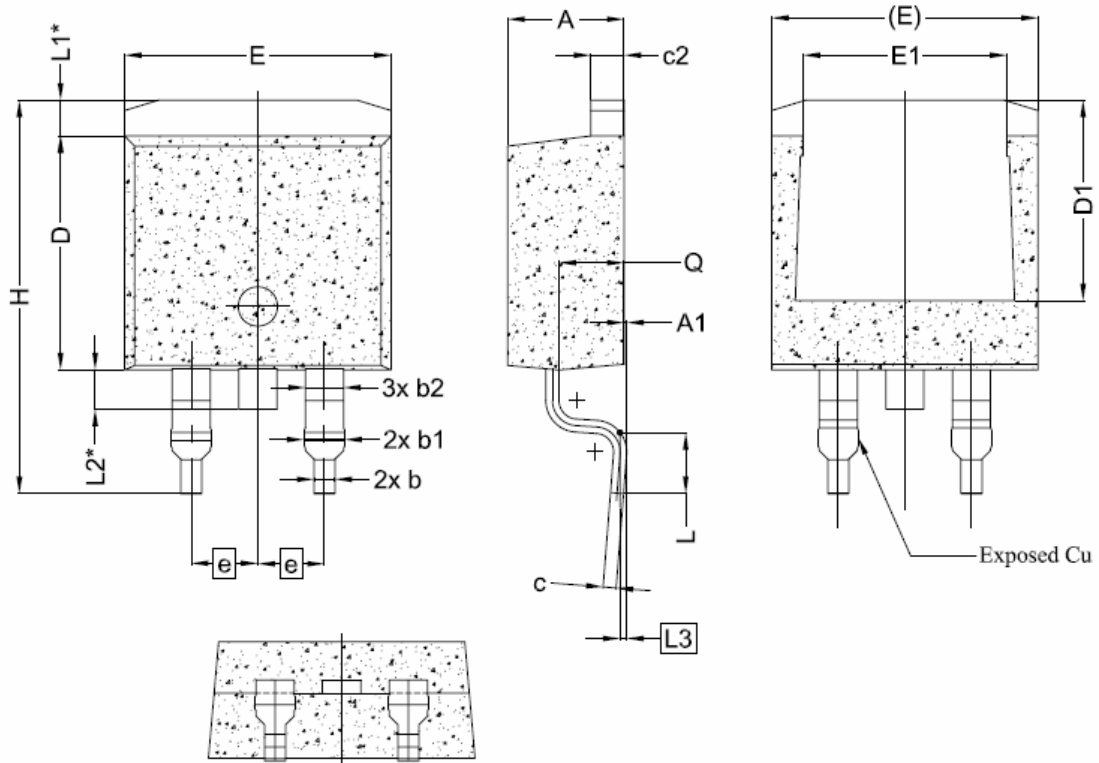

SYMBOL	DIMENSIONS		
	MIN.	NOM.	MAX.
A	4.24	4.44	4.64
A1	0.00	0.10	0.25
b	0.70	0.80	0.90
b1	1.20	1.55	1.75
b2	1.20	1.45	1.70
c	0.40	0.50	0.60
c2	1.15	1.27	1.40
D	8.82	8.92	9.02
D1	6.86	7.65	—
E	9.96	10.16	10.36
E1	6.89	7.77	7.89
e	2.54 BSC		
H	14.61	15.00	15.88
L	1.78	2.32	2.79
L1	1.36 REF.		
L2	1.50 REF.		
L3	0.25 BSC		
Q	2.30	2.48	2.70

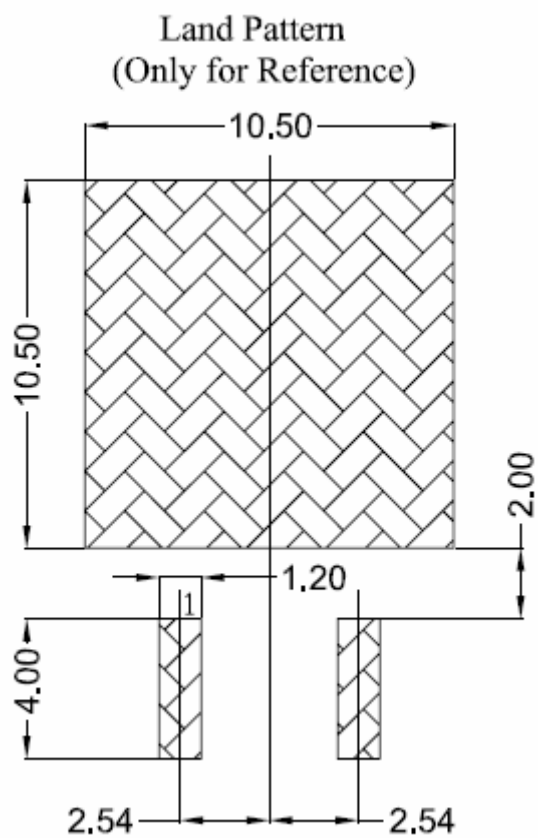

Attention

QIAOXIN assumes no responsibility for equipment failures that result from using products at values that exceed, even momentarily, rated values (such as maximum ratings, operating condition ranges, or other parameters) listed in products specifications of any and all QIAOXIN products described or contained herein. QIAOXIN products are not designed for use in life support appliances, devices or systems where malfunction of these products can be reasonably expected to result in personal injury. Reproduction in whole or in part is prohibited without the prior written consent of the copyright owner. QIAOXIN reserves the right to make changes to information published in this document, including without limitation specifications and product descriptions, at any time and without notice. This document supersedes and replaces all information supplied prior to the publication hereof.