

## QIANXIN N-Channel Super Trench II Power MOSFET

### Description

The series of devices uses **Super Trench II** technology that is uniquely optimized to provide the most efficient high frequency switching performance. Both conduction and switching power losses are minimized due to an extremely low combination of  $R_{DS(ON)}$  and  $Q_g$ . This device is ideal for high-frequency switching and synchronous rectification.

### Application

- DC/DC Converter
- Ideal for high-frequency switching and synchronous rectification

### General Features

- $V_{DS} = 85V, I_D = 300A$   
 $R_{DS(ON)} = 1.8m\Omega$ , typical (TO-220) @  $V_{GS} = 10V$   
 $R_{DS(ON)} = 1.6m\Omega$ , typical (TO-263) @  $V_{GS} = 10V$
- Excellent gate charge x  $R_{DS(on)}$  product (FOM)
- Very low on-resistance  $R_{DS(on)}$
- 175 °C operating temperature
- Pb-free lead plating

TO-220

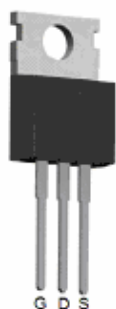

TO-263

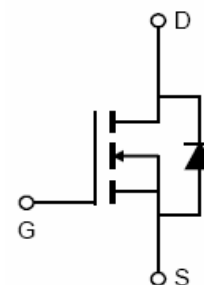
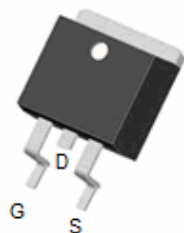

Schematic Diagram

### Package Marking and Ordering Information

Device Marking	Device	Device Package	Reel Size	Tape width	Quantity
VCRR020N85	VCRR020N85	TO-220	-	-	-
VCRR020N85D	VCRR020N85D	TO-263	-	-	-

### Absolute Maximum Ratings ( $T_C = 25^\circ C$ unless otherwise noted)

Parameter	Symbol	Limit	Unit
Drain-Source Voltage	$V_{DS}$	85	V
Gate-Source Voltage	$V_{GS}$	$\pm 20$	V
Drain Current-Continuous	$I_D$	300	A
Drain Current-Continuous ( $T_C = 100^\circ C$ )	$I_D(100^\circ C)$	220	A
Pulsed Drain Current	$I_{DM}$	1200	A
Maximum Power Dissipation	$P_D$	340	W
Derating factor		2.27	W/ $^\circ C$
Single pulse avalanche energy <sup>(Note 5)</sup>	$E_{AS}$	2850	mJ
Operating Junction and Storage Temperature Range	$T_J, T_{STG}$	-55 To 175	$^\circ C$

## Thermal Characteristic

Thermal Resistance, Junction-to-Case	$R_{\theta JC}$	0.44	$^{\circ}C/W$
--------------------------------------	-----------------	------	---------------

## Electrical Characteristics ( $T_C=25^{\circ}C$ unless otherwise noted)

Parameter	Symbol	Condition	Min	Typ	Max	Unit	
<b>Off Characteristics</b>							
Drain-Source Breakdown Voltage	$BV_{DSS}$	$V_{GS}=0V, I_D=250\mu A$	85		-	V	
Zero Gate Voltage Drain Current	$I_{DSS}$	$V_{DS}=85V, V_{GS}=0V$	-	-	1	$\mu A$	
Gate-Body Leakage Current	$I_{GSS}$	$V_{GS}=\pm 20V, V_{DS}=0V$	-	-	$\pm 100$	nA	
<b>On Characteristics</b> (Note 3)							
Gate Threshold Voltage	$V_{GS(th)}$	$V_{DS}=V_{GS}, I_D=250\mu A$	2.0	3.0	4.0	V	
Drain-Source On-State Resistance	$R_{DS(on)}$	$V_{GS}=10V, I_D=150A$	TO-220	-	1.8	2.0	m $\Omega$
			TO-263		1.6	2.0	m $\Omega$
Forward Transconductance	$g_{FS}$	$V_{DS}=5V, I_D=150A$		210	-	S	
<b>Dynamic Characteristics</b> (Note 4)							
Input Capacitance	$C_{iss}$	$V_{DS}=40V, V_{GS}=0V,$ $F=1.0MHz$	-	15800	-	PF	
Output Capacitance	$C_{oss}$		-	2450	-	PF	
Reverse Transfer Capacitance	$C_{rss}$		-	111	-	PF	
<b>Switching Characteristics</b> (Note 4)							
Turn-on Delay Time	$t_{d(on)}$	$V_{DD}=40V, I_D=150A$ $V_{GS}=10V, R_G=1.6\Omega$	-	43	-	nS	
Turn-on Rise Time	$t_r$		-	39	-	nS	
Turn-Off Delay Time	$t_{d(off)}$		-	108	-	nS	
Turn-Off Fall Time	$t_f$		-	40	-	nS	
Total Gate Charge	$Q_g$	$V_{DS}=40V, I_D=150A,$ $V_{GS}=10V$	-	245	-	nC	
Gate-Source Charge	$Q_{gs}$		-	66		nC	
Gate-Drain Charge	$Q_{gd}$		-	65		nC	
<b>Drain-Source Diode Characteristics</b>							
Diode Forward Voltage (Note 3)	$V_{SD}$	$V_{GS}=0V, I_S=150A$	-		1.2	V	
Diode Forward Current	$I_S$		-	-	300	A	
Reverse Recovery Time	$t_{rr}$	$T_J = 25^{\circ}C, I_F = 150A$ $di/dt = 100A/\mu s$ (Note 3)	-	109	-	nS	
Reverse Recovery Charge	$Q_{rr}$		-	315	-	nC	

### Notes:

1. Repetitive Rating: Pulse width limited by maximum junction temperature.
2. Surface Mounted on FR4 Board,  $t \leq 10$  sec.
3. Pulse Test: Pulse Width  $\leq 300\mu s$ , Duty Cycle  $\leq 2\%$ .
4. Guaranteed by design, not subject to production
5. EAS condition :  $T_J=25^{\circ}C, V_{DD}=40V, V_G=10V, L=0.5mH, R_g=25\Omega$

**Typical Electrical and Thermal Characteristics**

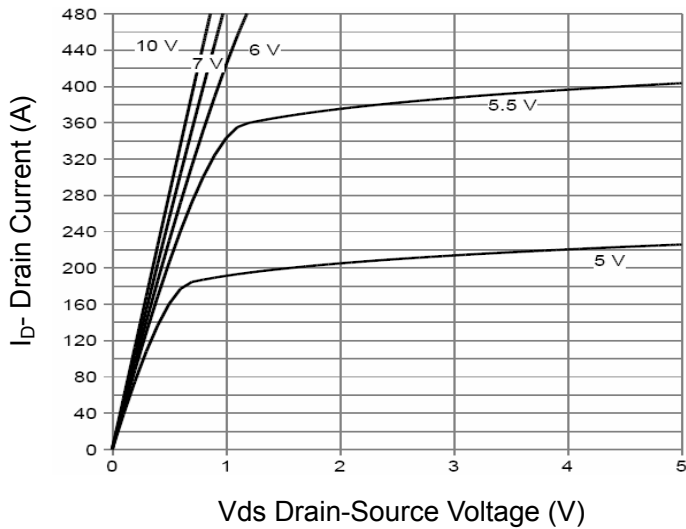

**Figure 1 Output Characteristics**

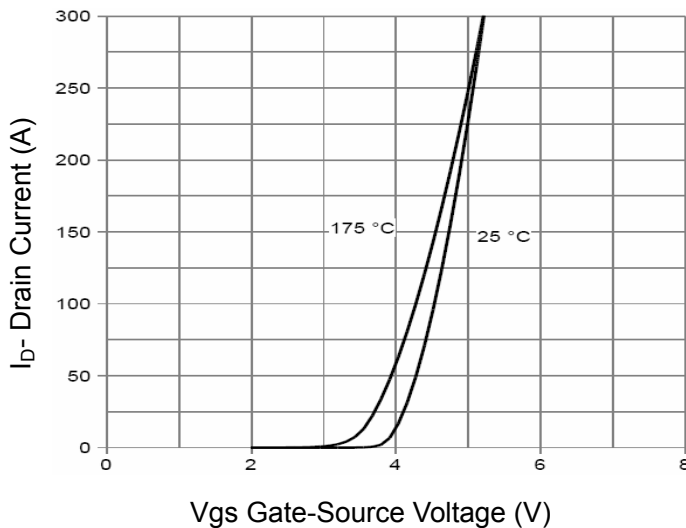

**Figure 2 Transfer Characteristics**

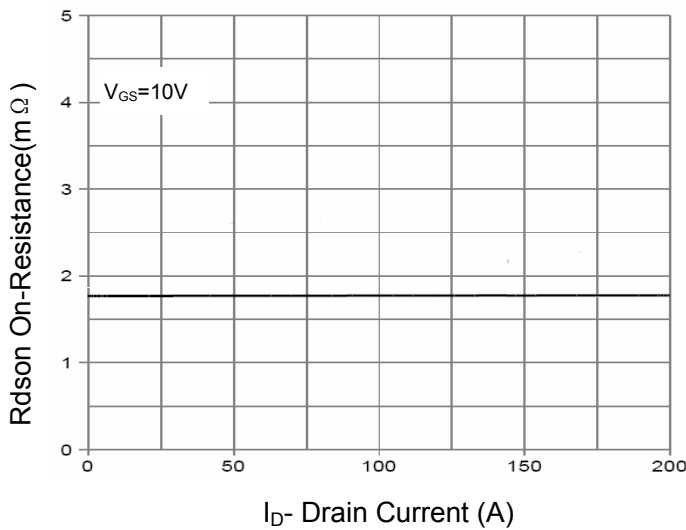

**Figure 3 Rdson- Drain Current**

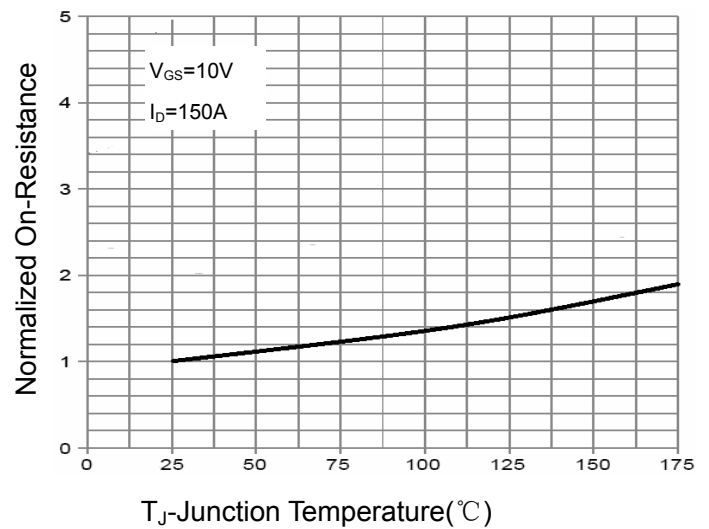

**Figure 4 Rdson-Junction Temperature**

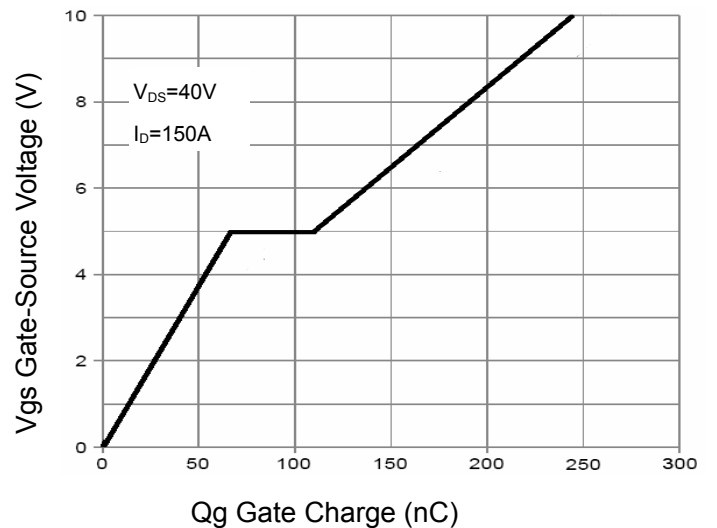

**Figure 5 Gate Charge**

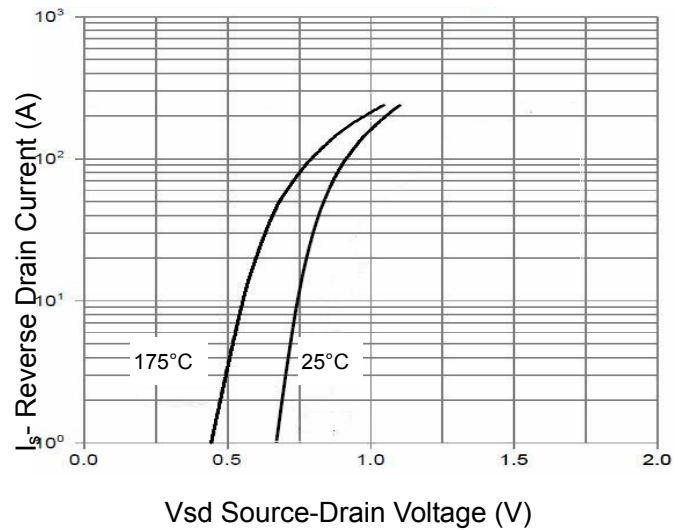

**Figure 6 Source- Drain Diode Forward**

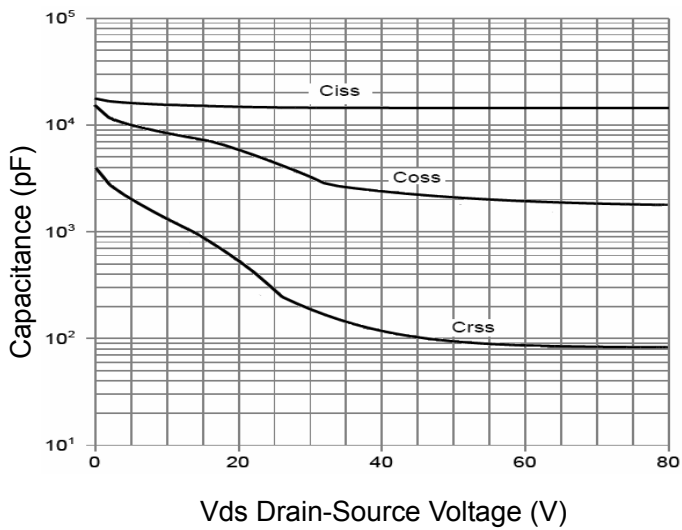

Vds Drain-Source Voltage (V)  
**Figure 7 Capacitance vs Vds**

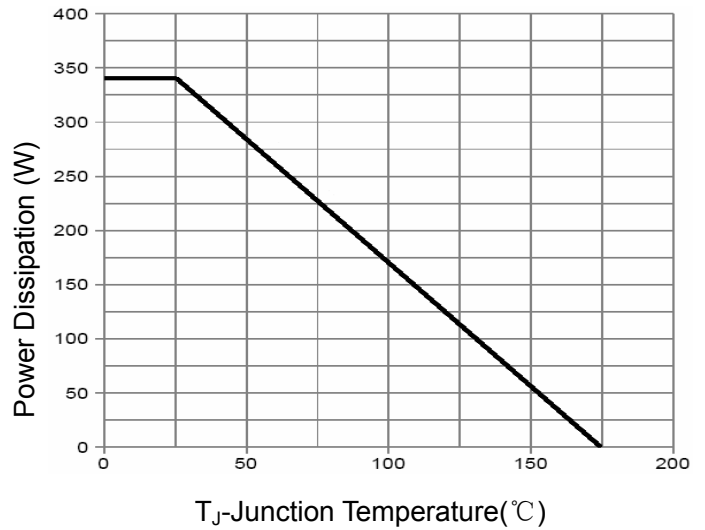

T<sub>J</sub>-Junction Temperature(°C)  
**Figure 9 Power De-rating**

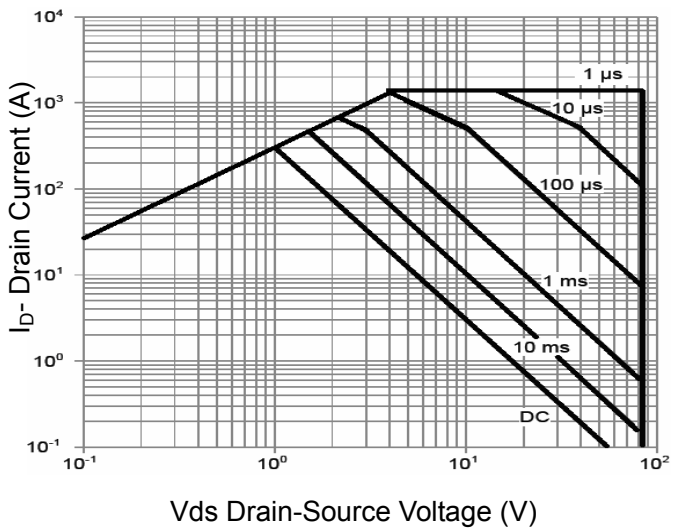

Vds Drain-Source Voltage (V)  
**Figure 8 Safe Operation Area**

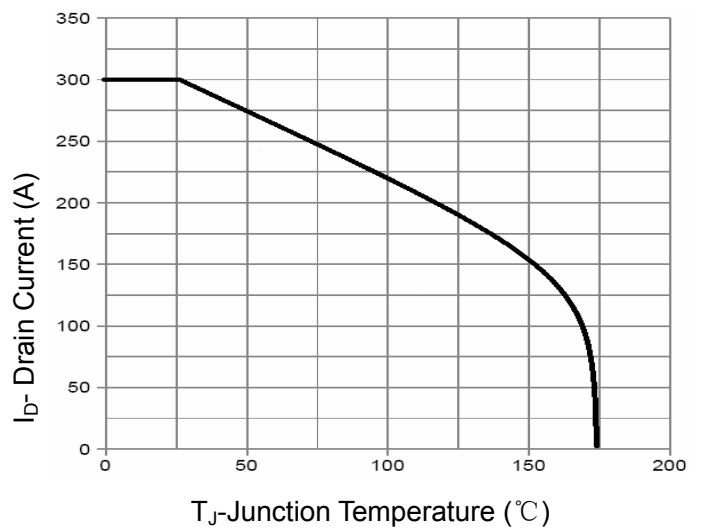

T<sub>J</sub>-Junction Temperature (°C)  
**Figure 10 Current De-rating**

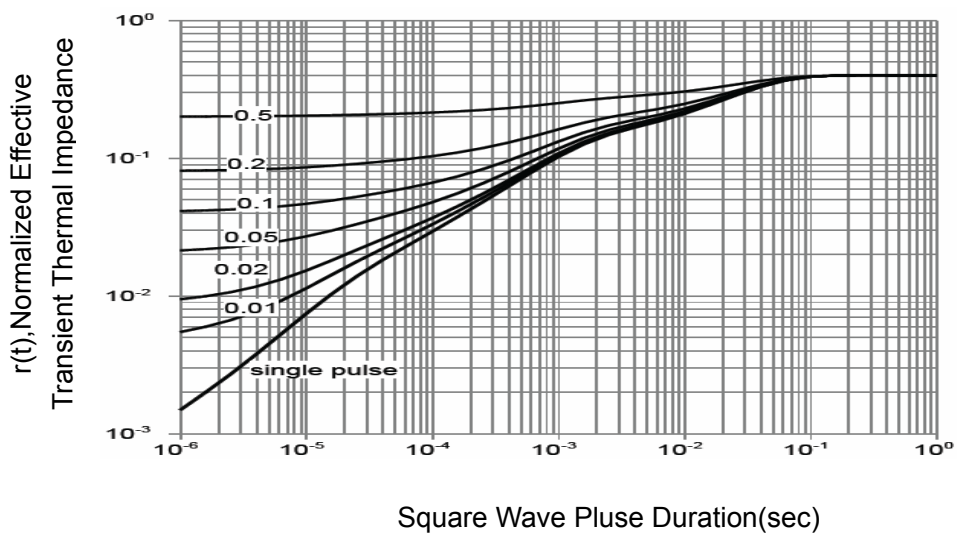

Square Wave Pluse Duration(sec)  
**Figure 11 Normalized Maximum Transient Thermal Impedance**

**TO-220-3L Package Information**

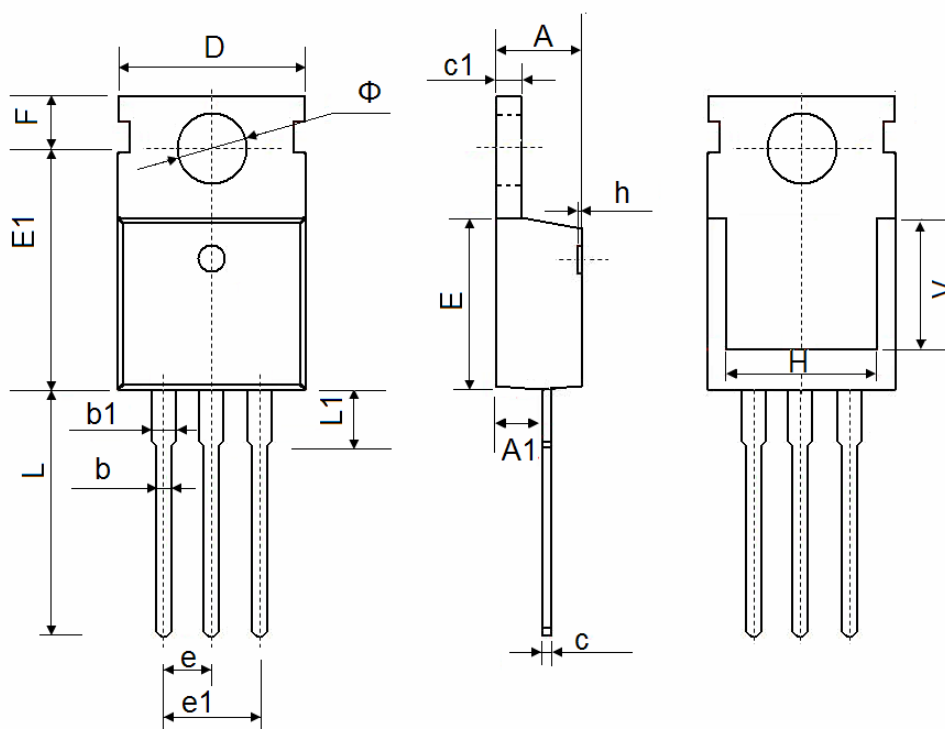

Symbol	Dimensions In Millimeters		Dimensions In Inches	
	Min.	Max.	Min.	Max.
A	4.400	4.600	0.173	0.181
A1	2.250	2.550	0.089	0.100
b	0.710	0.910	0.028	0.036
b1	1.170	1.370	0.046	0.054
c	0.330	0.650	0.013	0.026
c1	1.200	1.400	0.047	0.055
D	9.910	10.250	0.390	0.404
E	8.9500	9.750	0.352	0.384
E1	12.650	12.950	0.498	0.510
e	2.540 TYP.		0.100 TYP.	
e1	4.980	5.180	0.196	0.204
F	2.650	2.950	0.104	0.116
H	7.900	8.100	0.311	0.319
h	0.000	0.300	0.000	0.012
L	12.900	13.400	0.508	0.528
L1	2.850	3.250	0.112	0.128
V	6.900 REF.		0.276 REF.	
Φ	3.400	3.800	0.134	0.150

## TO-263-2L Package Information

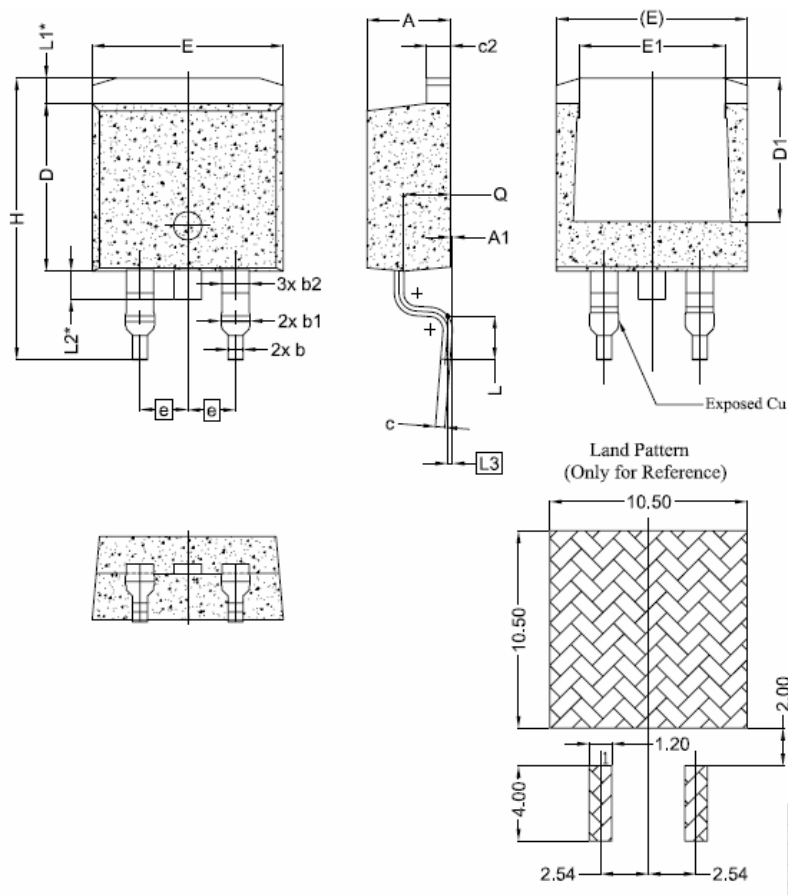

SYMBOL	DIMENSIONS		
	MIN.	NOM.	MAX.
A	4.24	4.44	4.64
A1	0.00	0.10	0.25
b	0.70	0.80	0.90
b1	1.20	1.55	1.75
b2	1.20	1.45	1.70
c	0.40	0.50	0.60
c2	1.15	1.27	1.40
D	8.82	8.92	9.02
D1	6.86	7.65	—
E	9.96	10.16	10.36
E1	6.89	7.77	7.89
e	2.54 BSC		
H	14.61	15.00	15.88
L	1.78	2.32	2.79
L1	1.36 REF.		
L2	1.50 REF.		
L3	0.25 BSC		
Q	2.30	2.48	2.70

### **Attention**

QIAOXIN assumes no responsibility for equipment failures that result from using products at values that exceed, even momentarily, rated values (such as maximum ratings, operating condition ranges, or other parameters) listed in products specifications of any and all QIAOXIN products described or contained herein. QIAOXIN products are not designed for use in life support appliances, devices or systems where malfunction of these products can be reasonably expected to result in personal injury. Reproduction in whole or in part is prohibited without the prior written consent of the copyright owner. QIAOXIN reserves the right to make changes to information published in this document, including without limitation specifications and product descriptions, at any time and without notice. This document supersedes and replaces all information supplied prior to the publication hereof.