

600V, 80A, Trench FS II Fast IGBT

General Description:

Using VCRR's proprietary trench design and advanced FS (Field Stop) second generation technology, the 600V Trench FSII IGBT offers superior conduction and switching performances, and easy parallel operation;

Features

- Trench FSII Technology offering
- Very low $V_{CE(sat)}$
- High speed switching
- Positive temperature coefficient in $V_{CE(sat)}$
- Very tight parameter distribution
- High ruggedness, temperature stable behavior

Application

- Air Condition
- Inverters
- Motor drives

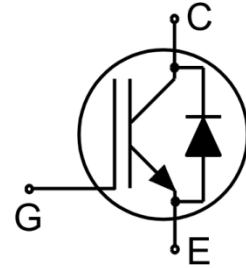

Schematic diagram

Package Marking and Ordering Information

Device	Device Package	Device Marking
VCRR80TD60BT	TO-247	VCRR80TD60BT



Absolute Maximum Ratings ($T_C=25^{\circ}C$ unless otherwise noted)

Symbol	Parameter	Value	Units
V_{CES}	Collector-Emitter Voltage	600	V
V_{GES}	Gate- Emitter Voltage	± 30	V
I_C	Collector Current	160	A
	Collector Current @ $T_C = 100^{\circ}C$	80	A
I_{Cpuls}	Pulsed Collector Current, t_p limited by T_{jmax}	320	A
-	Turn off safe operating area, $V_{CE}=600V, T_j=175^{\circ}C$	320	A
I_F	Diode Continuous Forward Current @ $T_C = 100^{\circ}C$	80	A
I_{FM}	Diode Maximum Forward Current	320	A
P_D	Power Dissipation @ $T_C = 25^{\circ}C$	468	W
	Power Dissipation @ $T_C = 100^{\circ}C$	234	W
T_J, T_{stg}	Operating Junction and Storage Temperature Range	-55 to +175	$^{\circ}C$
T_L	Maximum Temperature for Soldering	260	$^{\circ}C$
t_{sc}	Short circuit withstand time $V_{GE}=15V, V_{CC}\leq 400V$, Allowed number of short circuits<1000Time between short circuits: $\geq 1.0s, T_j\leq 150^{\circ}C$	5	us

Thermal Characteristic

Symbol	Parameter	Value	Units
$R_{\theta JC}$	Thermal Resistance, Junction to case for IGBT	0.32	$^{\circ}\text{C}/\text{W}$
$R_{\theta JC}$	Thermal Resistance, Junction to case for Diode	0.44	$^{\circ}\text{C}/\text{W}$
$R_{\theta JA}$	Thermal Resistance, Junction to Ambient	40	$^{\circ}\text{C}/\text{W}$

Electrical Characteristics ($T_c=25^{\circ}\text{C}$ unless otherwise noted)

Symbol	Parameter	Conditions	Value			Units	
			Min.	Typ.	Max.		
Static Characteristics							
$V_{(BR)CES}$	Collector-Emitter Breakdown Voltage	$V_{GE}=0\text{V}, I_{CE}=1\text{mA}$	600	--	--	V	
I_{CES}	Collector-Emitter Leakage Current	$V_{GE}=0\text{V}, V_{CE}=600\text{V}$	--	--	75	μA	
$I_{GES(F)}$	Gate to Emitter Forward Leakage	$V_{GE}=+30\text{V}, V_{CE}=0\text{V}$	--	--	200	nA	
$I_{GES(R)}$	Gate to Emitter Reverse Leakage	$V_{GE}=-30\text{V}, V_{CE}=0\text{V}$	--	--	200	nA	
$V_{CE(sat)}$	Collector-Emitter Saturation Voltage	$I_C=80\text{A}$					
		$V_{GE}=15\text{V}$	$T_j=25^{\circ}\text{C}$	--	1.7	1.9	V
			$T_j=175^{\circ}\text{C}$	--	1.9	--	V
$V_{GE(th)}$	Gate Threshold Voltage	$I_C=1\text{mA}, V_{CE}=V_{GE}$	4.0	5.0	6.0	V	
Dynamic Characteristics							
C_{ies}	Input Capacitance	$V_{CE}=25\text{V}, V_{GE}=0\text{V},$ $f=1\text{MHz}$	--	9188	--	pF	
C_{oes}	Output Capacitance		--	258	--		
C_{res}	Reverse Transfer Capacitance		--	181	--		
Q_g	Total Gate Charge	$V_{CC}=480\text{V}, I_C=80\text{A},$ $V_{GE}=15\text{V}$	--	331	--	nC	
Q_{ge}	Gate to Emitter Charge		--	74	--		
Q_{gc}	Gate to Collector Charge		--	136	--		
$I_{C(SC)}$	Short circuit collector current Max.1000 short circuits Time between short circuits: $\geq 1.0\text{s}$	$V_{GE}=15\text{V}, V_{CC}\leq 400\text{V},$ $t_{sc}\leq 5\mu\text{s}, T_j\leq 150^{\circ}\text{C}$	--	450	--	A	
Switching Characteristics							
$t_{d(ON)}$	Turn-on Delay Time	$V_{CC}=400\text{V}, I_C=80\text{A},$ $V_{GE}=0/15\text{V}, R_g=5\Omega,$ Inductive Load	--	19	--	ns	
t_r	Rise Time		--	17	--		
$t_{d(OFF)}$	Turn-Off Delay Time		--	172	--		
t_f	Fall Time		--	20	--		
E_{on}	Turn-On Switching Loss		$V_{CC}=400\text{V}, I_C=80\text{A},$ $V_{GE}=0/15\text{V}, R_g=5\Omega,$ $T_j=175^{\circ}\text{C}$	--	1.6	--	mJ
E_{off}	Turn-Off Switching Loss			--	1.2	--	
E_{ts}	Total Switching Loss			--	2.8	--	
E_{on}	Turn-On Switching Loss			--	2.0	--	mJ
E_{off}	Turn-Off Switching Loss	--	1.6	--			
E_{ts}	Total Switching Loss	--	3.6	--			

Electrical Characteristics of the Diode (T_c= 25°C unless otherwise specified)

Symbol	Parameter	Conditions	Rating			Units
			Min.	Typ.	Max.	
V _{FM}	Diode Forward Voltage	I _F =80A	--	1.75	2.2	V
T _{rr}	Reverse Recovery Time	I _F =80A, di/dt=200A/us	--	194	--	ns
I _{RRM}	Diode Peak Reverse Recovery Current		--	2.8	--	A
Q _{rr}	Reverse Recovery Charge		--	0.2	--	uC

Test Circuit

1) Gate Charge Test Circuit

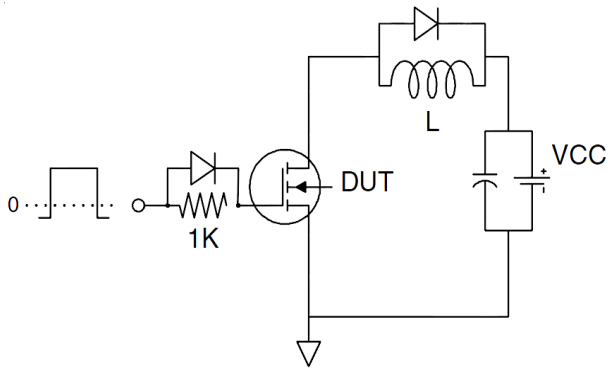

2) Switch Time Test Circuit

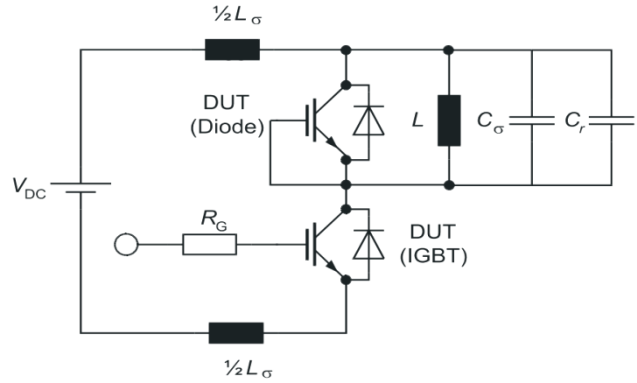

Switching characteristics

1) Definition of switching times

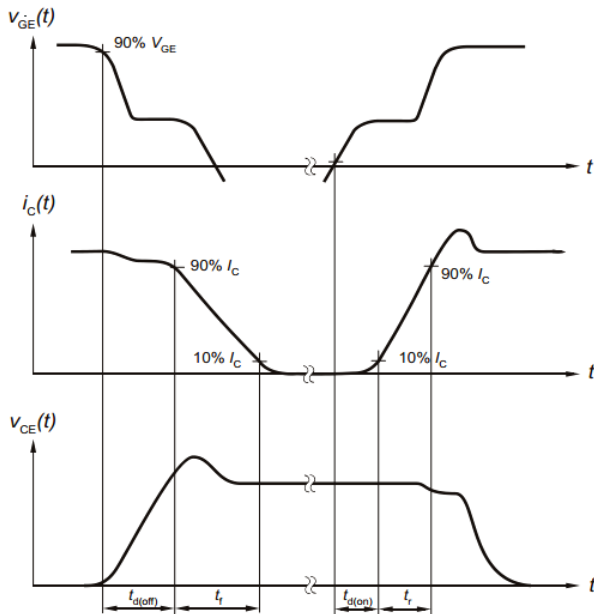

2) Definition of switching losses

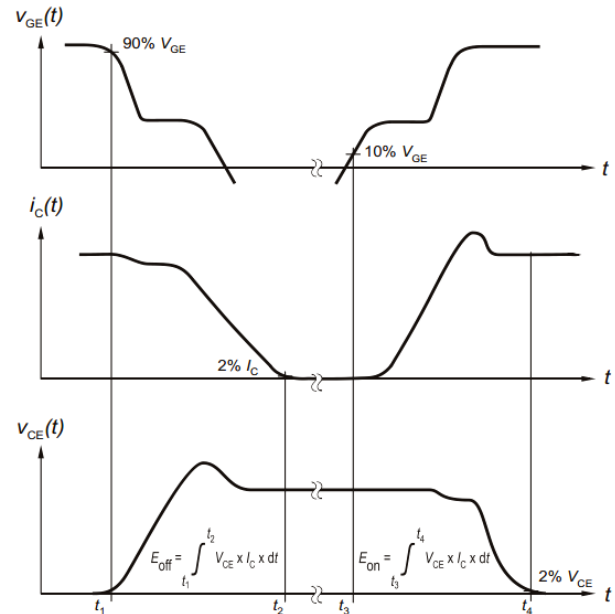

3) Definition of diode switching characteristics

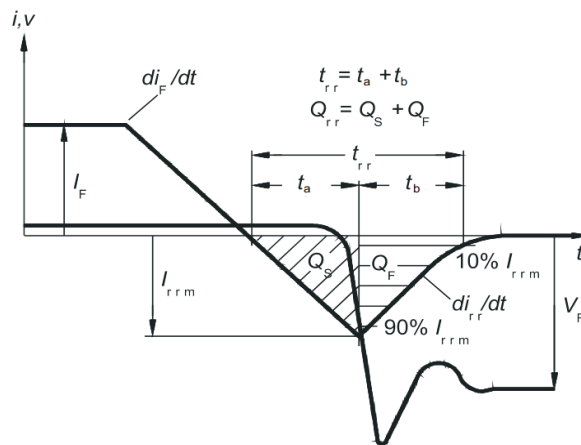

Typical Electrical and Thermal Characteristics

Figure 1 Output Characteristics

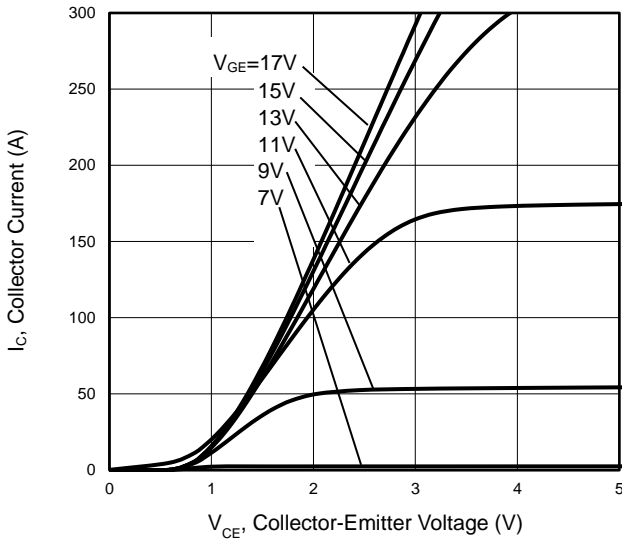

Figure 2 Transfer Characteristics

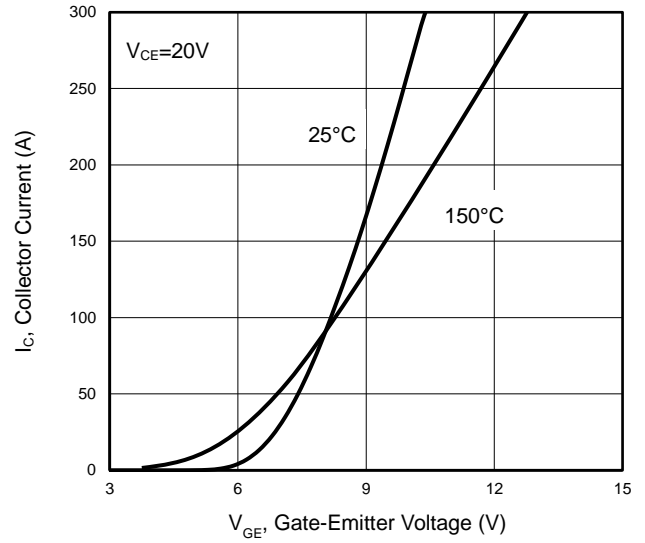

Figure 3 $V_{CE(sat)}$ vs. Temperature

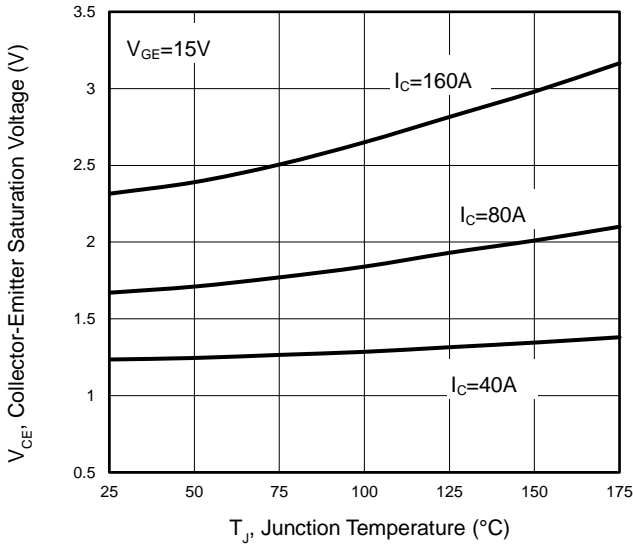

Figure 4 Saturation Voltage vs. V_{GE}

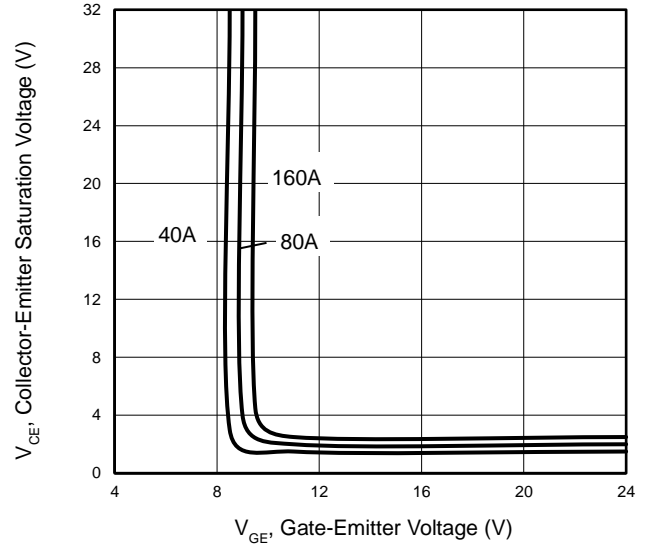

Figure 5 Capacitance Characteristics

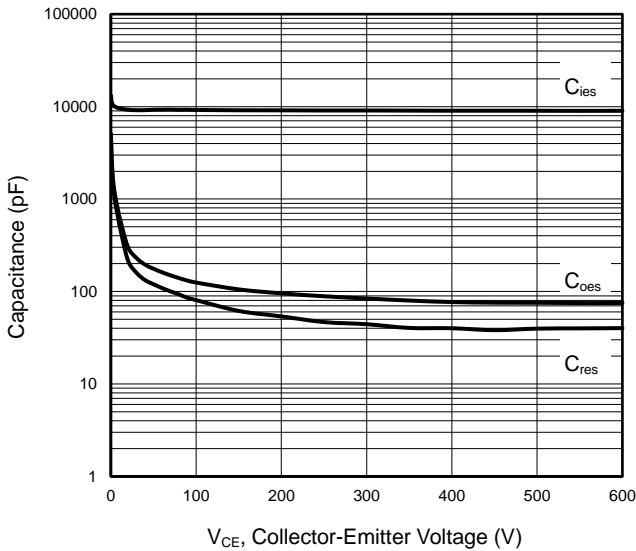
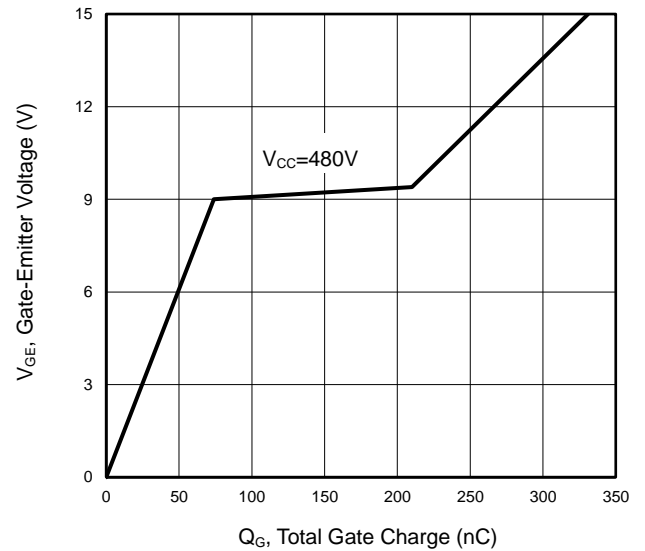

Figure 6 Gate Charge Wave Form



Typical Electrical and Thermal Characteristics

Figure 7 Forward Characteristics

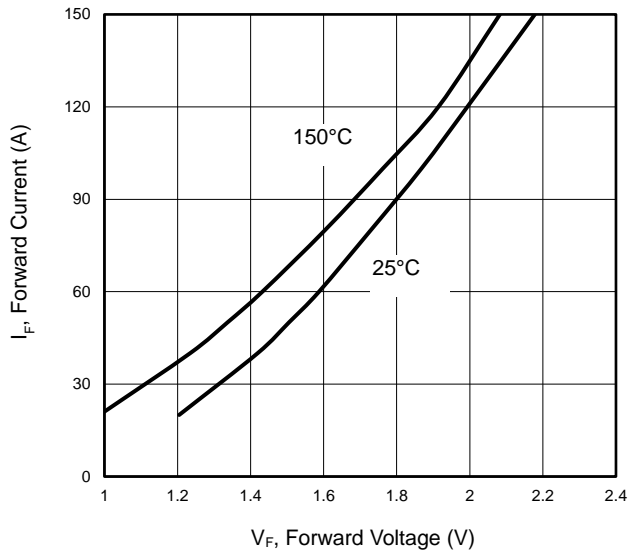

Figure 8 V_F vs. Temperature

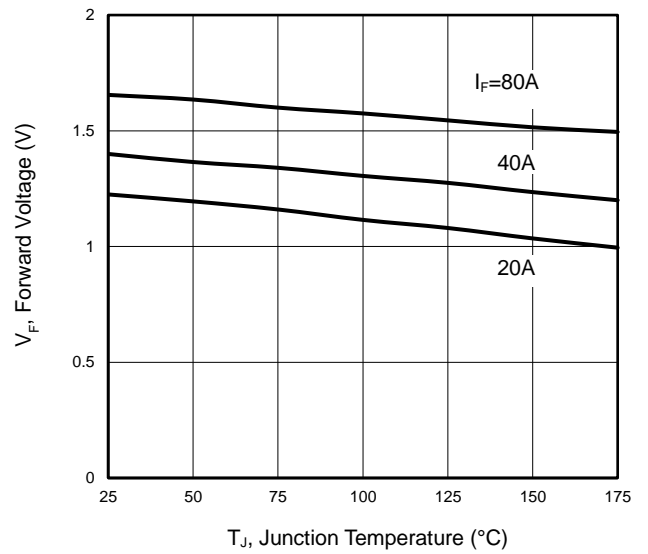

Figure 9 $V_{GE(th)}$ vs. Temperature

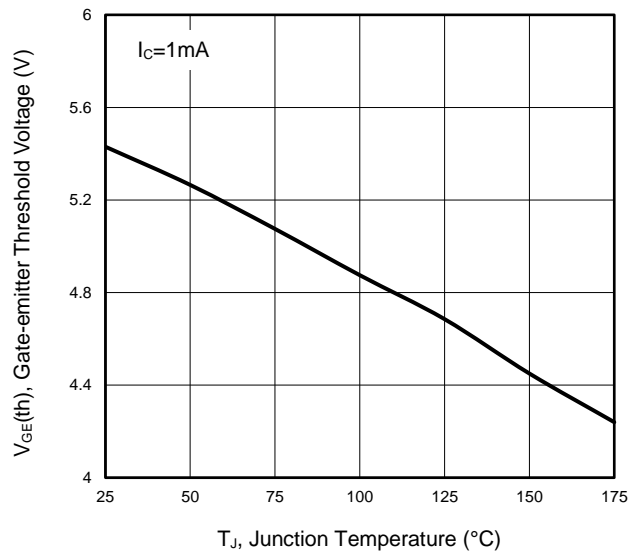

Figure 10 $V_{CE(sat)}$ vs. Collector Current

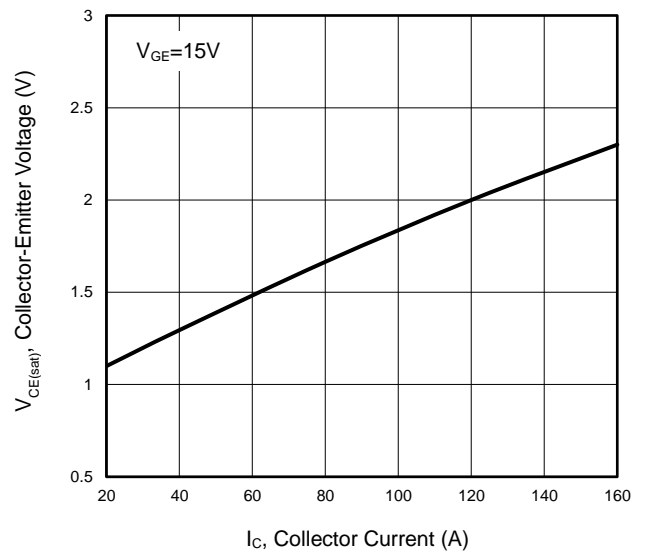

Figure 11 P_{tot} vs. Case Temperature

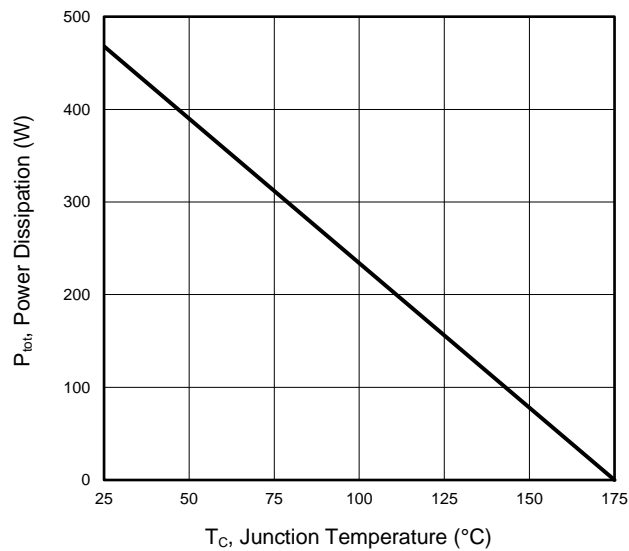
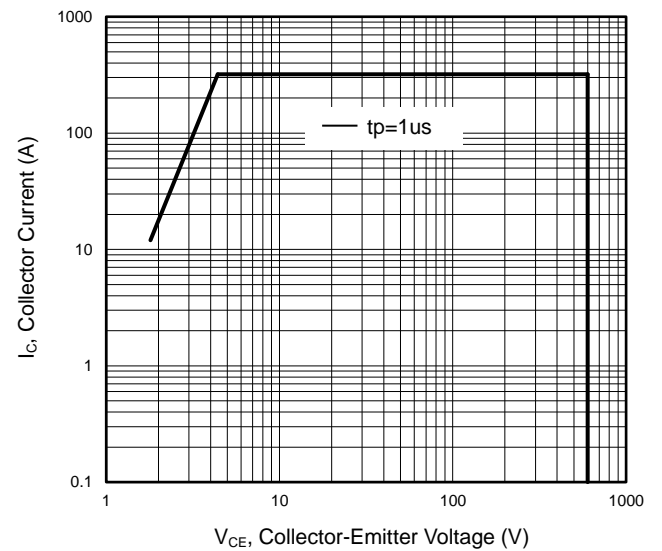

Figure 12 Forward Bias Safe Operating Area



Typical Electrical and Thermal Characteristics

Figure 13 Switching Loss vs. R_G

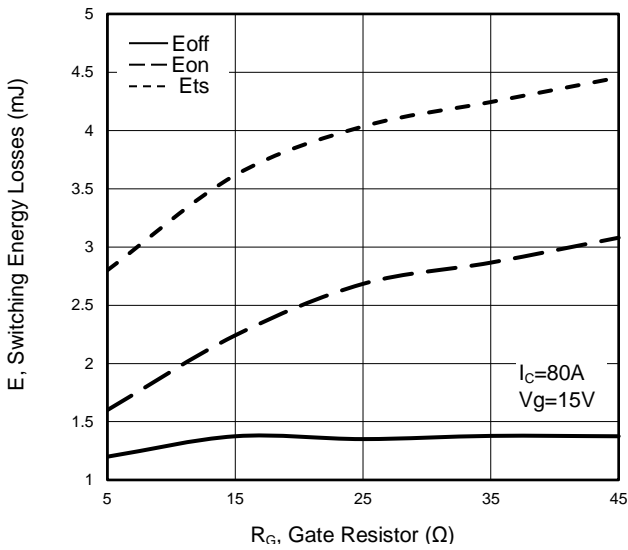

Figure 14 Switching Loss vs. Collector Current

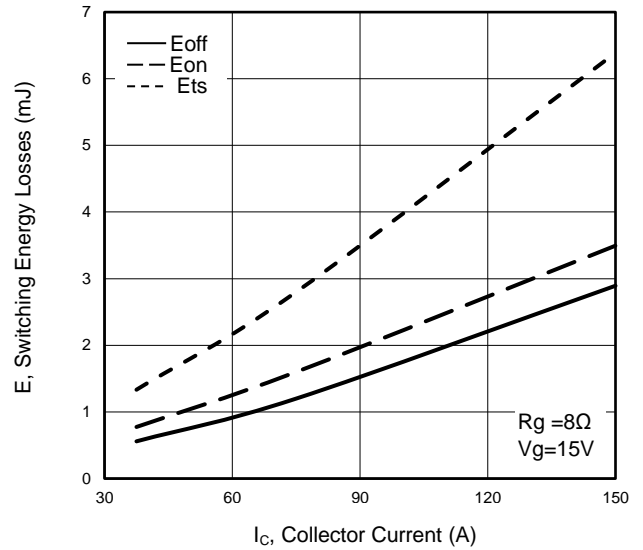

Figure 15 Switching Energy vs. Temperature

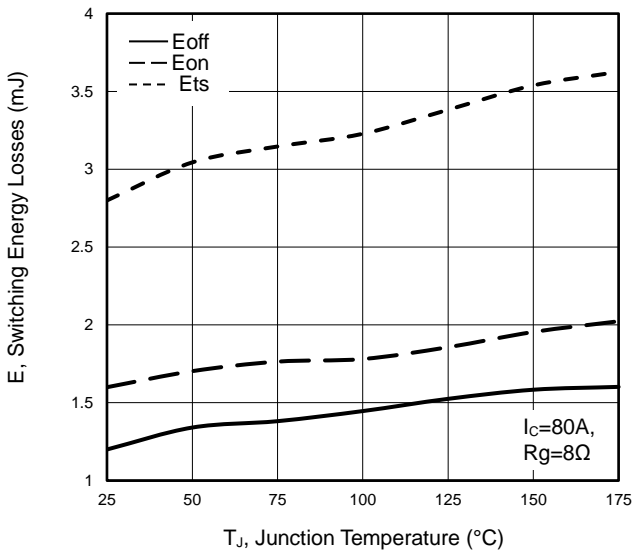

Figure 16 Switching Loss vs. Collector Current

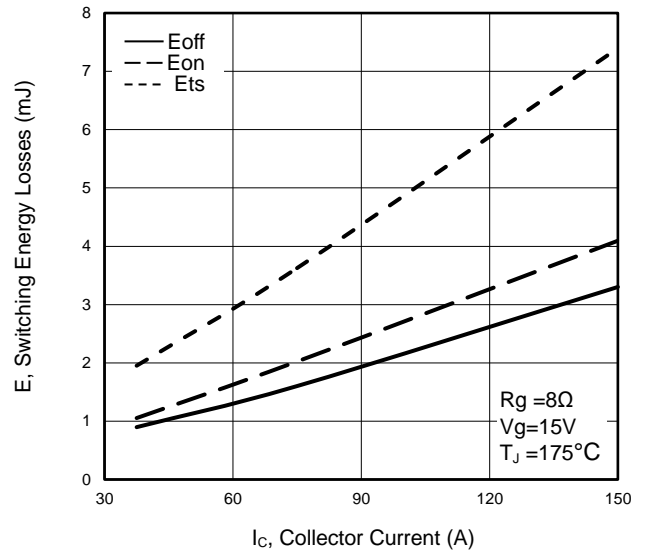

Figure 17 V_{CES} vs. Case Temperature

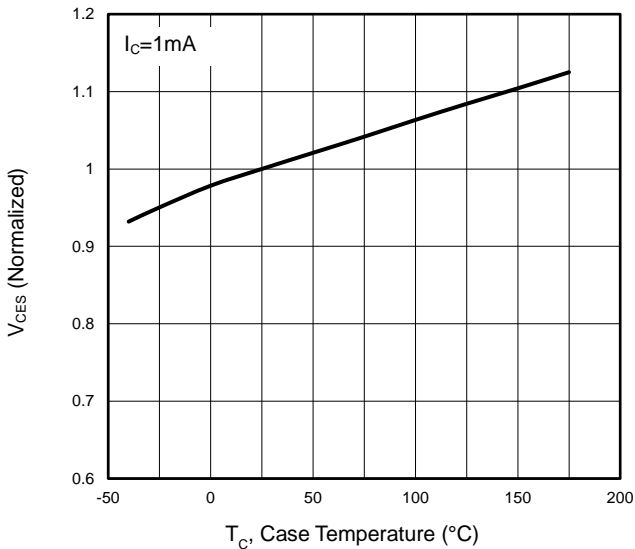
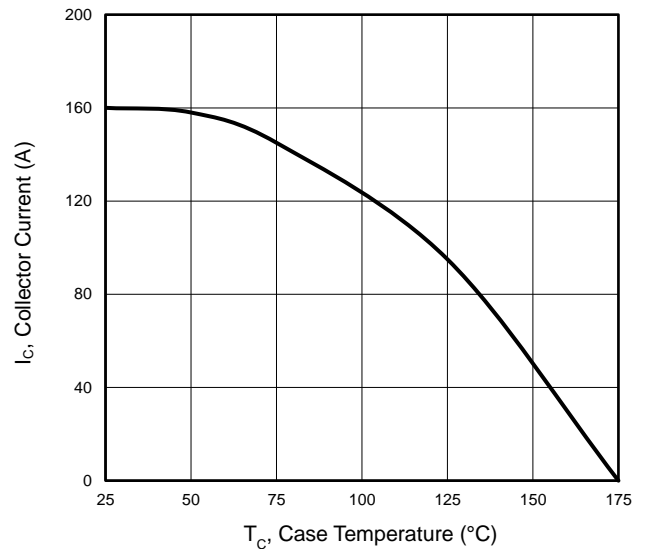
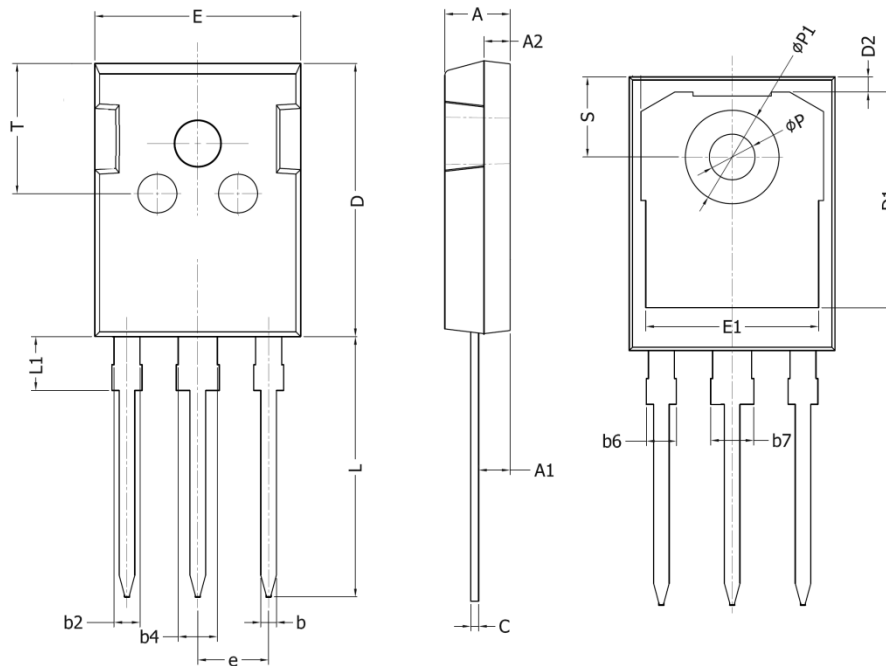

Figure 18 I_C vs. Temperature



TO-247-3L Package Information



Symbol	Dimensions In Millimeters		Dimensions In Inches	
	Min.	Max.	Min.	Max.
A	4.90	5.10	0.193	0.201
A1	2.31	2.51	0.091	0.099
A2	1.9	2.1	0.075	0.083
b	1.16	1.26	0.046	0.050
b2	1.96	2.06	0.077	0.081
b4	2.96	3.06	0.117	0.120
b6	-	2.25	-	0.089
b7	-	3.25	-	0.128
C	0.59	0.66	0.023	0.026
D	20.90	21.10	0.823	0.831
D1	16.25	16.85	0.640	0.663
D2	1.05	1.35	0.041	0.053
E	15.70	15.90	0.618	0.626
E1	13.10	13.50	0.516	0.531
e	5.436 BSC		0.214 BSC	
L	19.80	20.10	0.780	0.791
L1	-	4.30	-	0.169
P	3.40	3.60	0.134	0.142
P1	7.00	7.40	0.276	0.291
S	6.05	6.25	0.238	0.246
T	9.80	10.20	0.386	0.402

Attention

QIAOXIN assumes no responsibility for equipment failures that result from using products at values that exceed, even momentarily, rated values (such as maximum ratings, operating condition ranges, or other parameters) listed in products specifications of any and all QIAOXIN products described or contained herein. QIAOXIN products are not designed for use in life support appliances, devices or systems where malfunction of these products can be reasonably expected to result in personal injury. Reproduction in whole or in part is prohibited without the prior written consent of the copyright owner. QIAOXIN reserves the right to make changes to information published in this document, including without limitation specifications and product descriptions, at any time and without notice. This document supersedes and replaces all information supplied prior to the publication hereof.