

QIAOXIN N-Channel Super Junction Power MOSFET III

<p>General Description</p> <p>The series of devices use advanced trench gate super junction technology and design to provide excellent $R_{DS(ON)}$ with low gate charge. This super junction MOSFET fits the industry's AC-DC SMPS requirements for PFC, AC/DC power conversion, and industrial power applications.</p> <p>Features</p> <ul style="list-style-type: none"> ● New technology for high voltage device ● Low on-resistance and low conduction losses ● small package ● Ultra Low Gate Charge cause lower driving requirements ● 100% Avalanche Tested ● ROHS compliant <p>Application</p> <ul style="list-style-type: none"> ● Power factor correction (PFC) ● Switched mode power supplies(SMPS) ● Uninterruptible Power Supply (UPS) 	<table border="1" style="width: 100%; border-collapse: collapse; margin-bottom: 10px;"> <tr> <td>V_{DS}</td> <td>700</td> <td>V</td> </tr> <tr> <td>$R_{DS(ON)TYP}$</td> <td>330</td> <td>mΩ</td> </tr> <tr> <td>I_D</td> <td>11.5</td> <td>A</td> </tr> </table> <div style="text-align: center;">  <p>Schematic diagram</p> </div>	V_{DS}	700	V	$R_{DS(ON)TYP}$	330	m Ω	I_D	11.5	A
V_{DS}	700	V								
$R_{DS(ON)TYP}$	330	m Ω								
I_D	11.5	A								

Package Marking And Ordering Information

Device	Device Package	Marking
VCRR 70T360D	TO-263	VCRR70T360D
VCRR 70T360	TO-220	VCRR70T360
VCRR70T360F	TO-220F	VCRR 70T360F

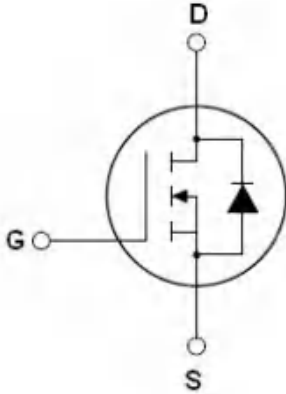
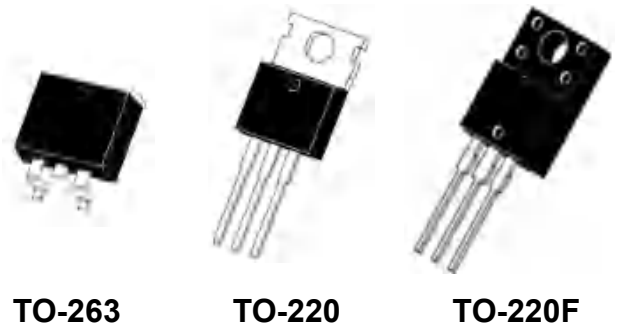

Table 1. Absolute Maximum Ratings ($T_c=25^\circ\text{C}$)

Parameter	Symbol			Unit
Drain-Source Voltage ($V_{GS}=0V$)	V_{DS}	700		V
Gate-Source Voltage ($V_{DS}=0V$), AC($f>1\text{HZ}$)	V_{GS}	± 30		V
Continuous Drain Current at $T_c = 25^\circ\text{C}$	$I_{D(DC)}$	11.5	11.5*	A
Continuous Drain Current at $T_c = 100^\circ\text{C}$	$I_{D(DC)}$	7	7*	A
Pulsed drain current (Note 1)	$I_{DM (pluse)}$	46	46*	A
Maximum Power Dissipation($T_c=25^\circ\text{C}$)	P_D	101	32.6	W
Derate above 25°C		0.81	0.26	W/ $^\circ\text{C}$
Single pulse avalanche energy (Note2)	E_{AS}	144		mJ
Avalanche current(Note 1)	I_{AR}	6		A
Repetitive Avalanche energy , t_{AR} limited by T_{jmax} (Note 1)	E_{AR}	0.5		mJ

Parameter	Symbol		Unit
Drain Source voltage slope, $V_{DS} \leq 480V$,	dv/dt	50	V/ns
Reverse diode dv/dt, $V_{DS} \leq 480V, I_{SD} < I_D$	dv/dt	15	V/ns
Operating Junction and Storage Temperature Range	T_J, T_{STG}	-55...+150	°C

* limited by maximum junction temperature

Table 2. Thermal Characteristic

Parameter	Symbol			Unit
Thermal Resistance, Junction-to-Case (Maximum)	R_{thJC}	1.24	3.83	°C/W
Thermal Resistance, Junction-to-Ambient (Maximum)	R_{thJA}	62	80	°C/W

Table 3. Electrical Characteristics (TA=25°C unless otherwise noted)

Parameter	Symbol	Condition	Min	Typ	Max	Unit
On/off states						
Drain-Source Breakdown Voltage	BV_{DSS}	$V_{GS}=0V, I_D=250\mu A$	700			V
Zero Gate Voltage Drain Current($T_C=25^\circ C$)	I_{DSS}	$V_{DS}=700V, V_{GS}=0V$		0.05	1	μA
Zero Gate Voltage Drain Current($T_C=125^\circ C$)	I_{DSS}	$V_{DS}=700V, V_{GS}=0V$			100	μA
Gate-Body Leakage Current	I_{GSS}	$V_{GS}=\pm 20V, V_{DS}=0V$			± 100	nA
Gate Threshold Voltage	$V_{GS(th)}$	$V_{DS}=V_{GS}, I_D=250\mu A$	3	3.5	4	V
Drain-Source On-State Resistance	$R_{DS(on)}$	$V_{GS}=10V, I_D=7A$		330	390	m Ω
Dynamic Characteristics						
Input Capacitance	C_{iss}	$V_{DS}=50V, V_{GS}=0V,$ $F=1.0MHz$		870		pF
Output Capacitance	C_{oss}			54		pF
Reverse Transfer Capacitance	C_{rss}			1.8		pF
Total Gate Charge	Q_g	$V_{DS}=480V, I_D=11.5A,$ $V_{GS}=10V$		19		nC
Gate-Source Charge	Q_{gs}			6		nC
Gate-Drain Charge	Q_{gd}			6.5		nC
Switching times						
Turn-on Delay Time	$t_{d(on)}$	$V_{DD}=420V, I_D=5.5A,$ $R_G=3\Omega, V_{GS}=10V$		12		nS
Turn-on Rise Time	t_r			9		nS
Turn-Off Delay Time	$t_{d(off)}$			61	70	nS
Turn-Off Fall Time	t_f			11	14	nS
Source- Drain Diode Characteristics						
Source-drain current(Body Diode)	I_{SD}	$T_C=25^\circ C$			11.5	A
Pulsed Source-drain current(Body Diode)	I_{SDM}				46	A
Forward on voltage	V_{SD}	$T_J=25^\circ C, I_{SD}=11.5A, V_{GS}=0V$		0.9	1.2	V
Reverse Recovery Time	t_{rr}	$T_J=25^\circ C, I_F=5.8A,$ $di/dt=100A/\mu s$		220		nS
Reverse Recovery Charge	Q_{rr}			2.2		μC
Peak Reverse Recovery Current	I_{rrm}			19		A

Notes: 1.Repetitive Rating: Pulse width limited by maximum junction temperature

2. $T_J=25^\circ C, V_{DD}=50V, V_G=10V, R_G=25\Omega$

TYPICAL ELECTRICAL AND THERMAL CHARACTERISTICS (curves)

Figure1. Safe operating area

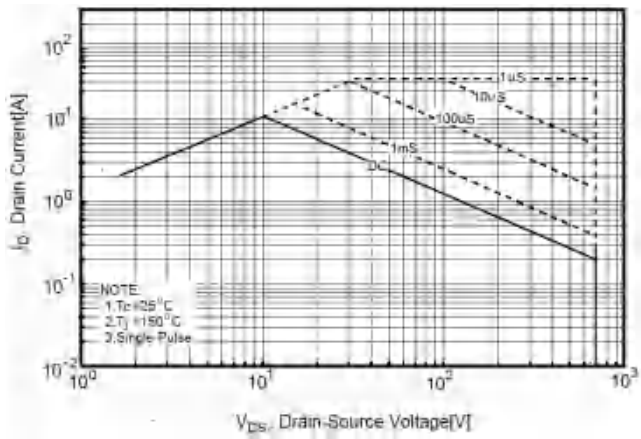

Figure2. Safe operating area for TO-220F

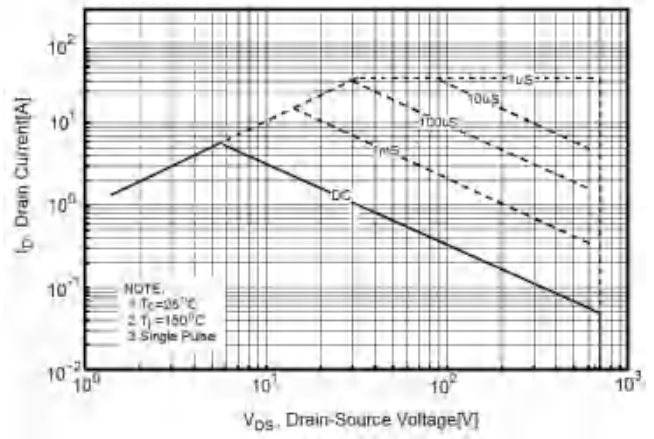

Figure3. Source-Drain Diode Forward Voltage

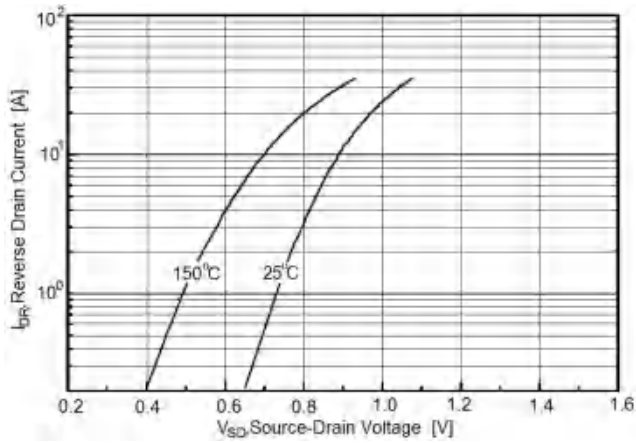

Figure4. Output characteristics

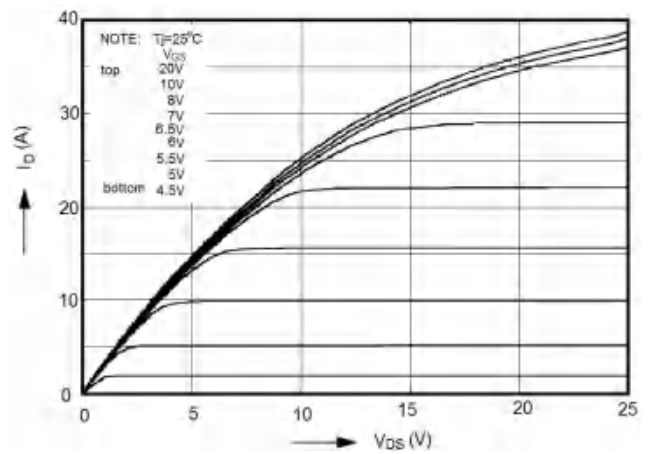

Figure5. Transfer characteristics

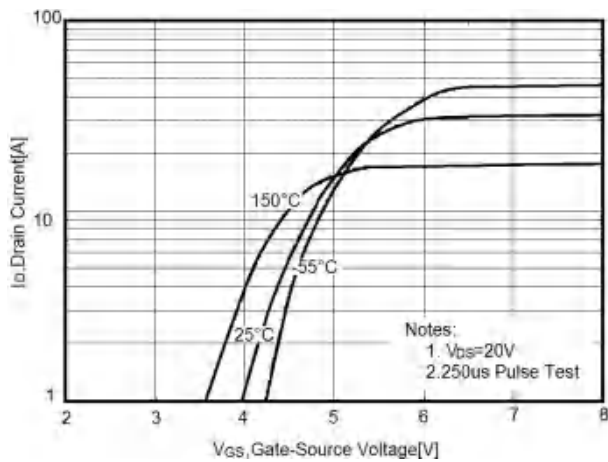

Figure6. Static drain-source on resistance

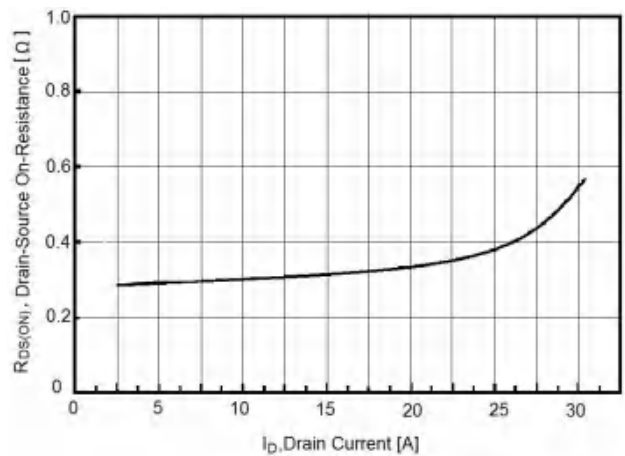

Figure7. $R_{DS(ON)}$ vs Junction Temperature

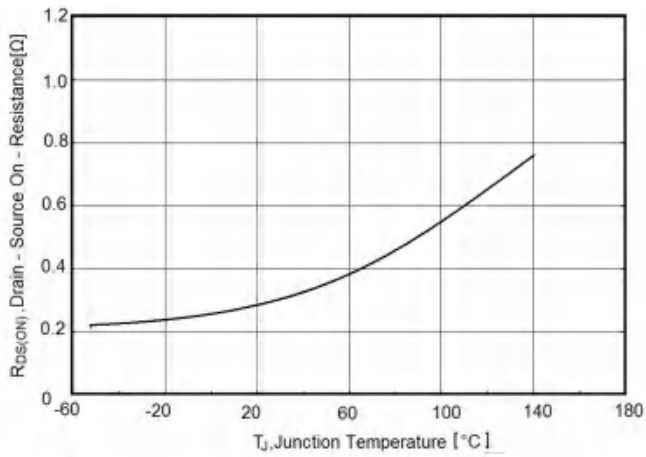

Figure8. BV_{DSS} vs Junction Temperature

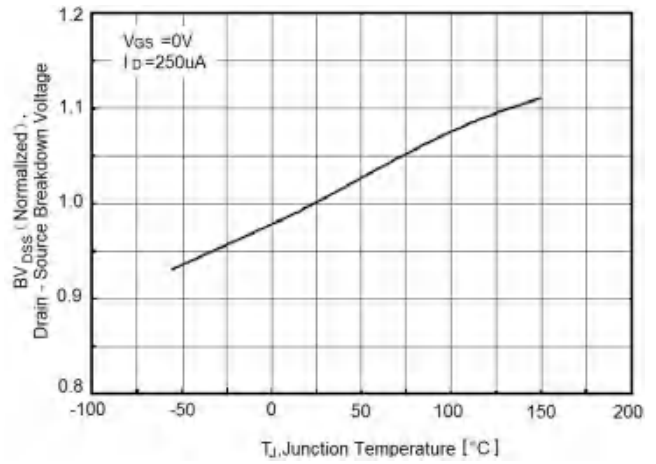

Figure9. Maximum I_D vs Junction Temperature

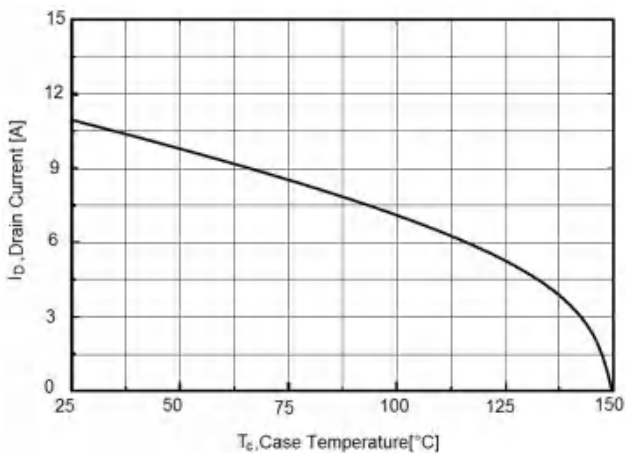

Figure10. Gate charge waveforms

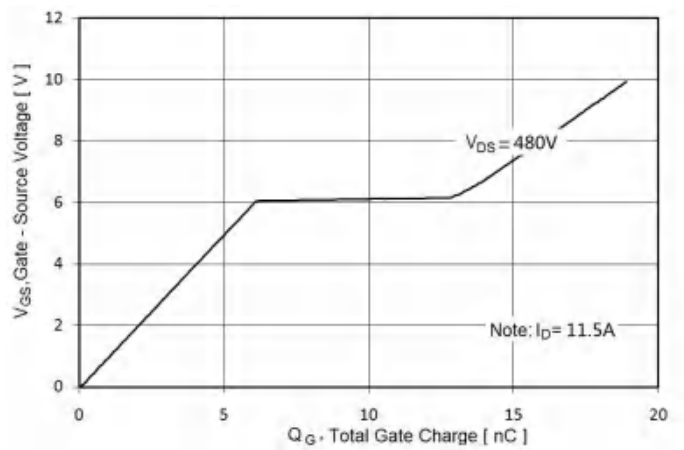

Figure11. Capacitance

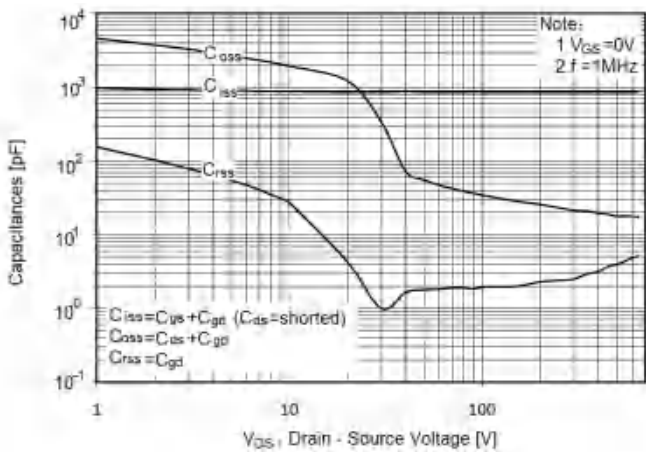

Figure12. Transient Thermal Impedance

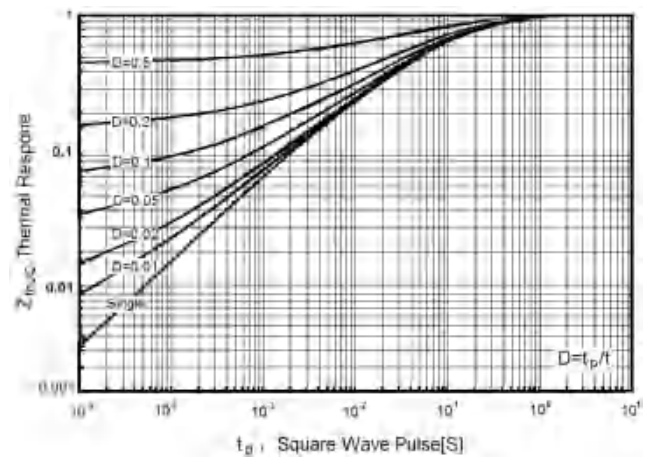
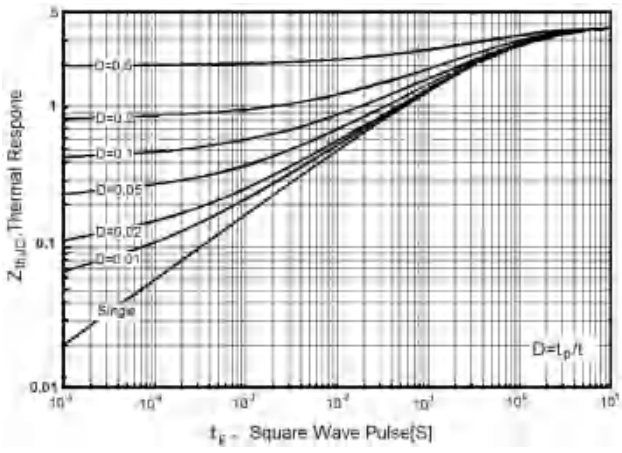
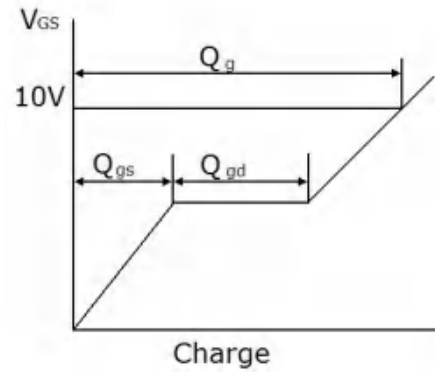
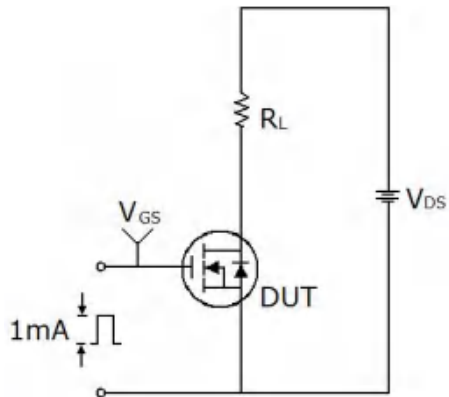

Figure13. Transient Thermal Impedance for TO-220F



Test circuit

1) Gate charge test circuit & Waveform



2) Switch Time Test Circuit:

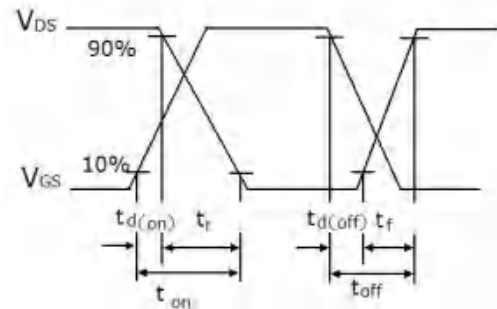
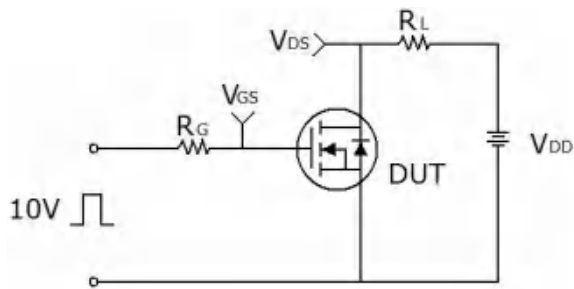

3) Unclamped Inductive Switching Test Circuit & Waveforms

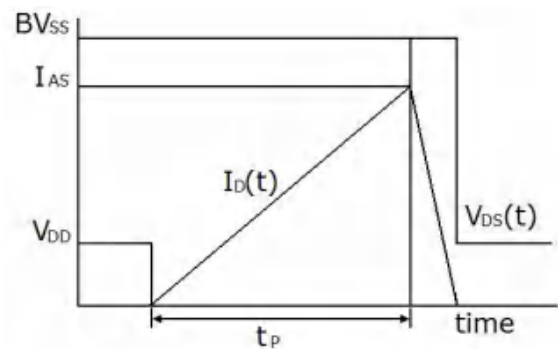
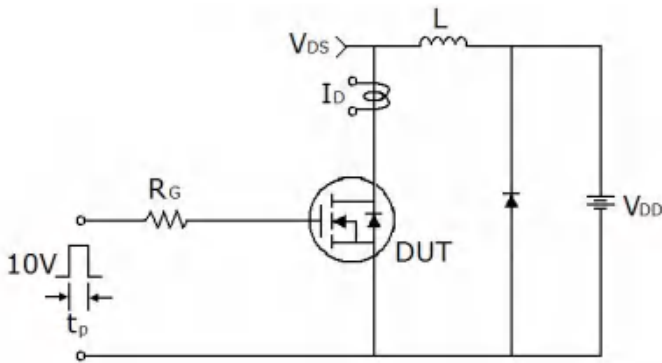

TO-263-3L集佳Package Information

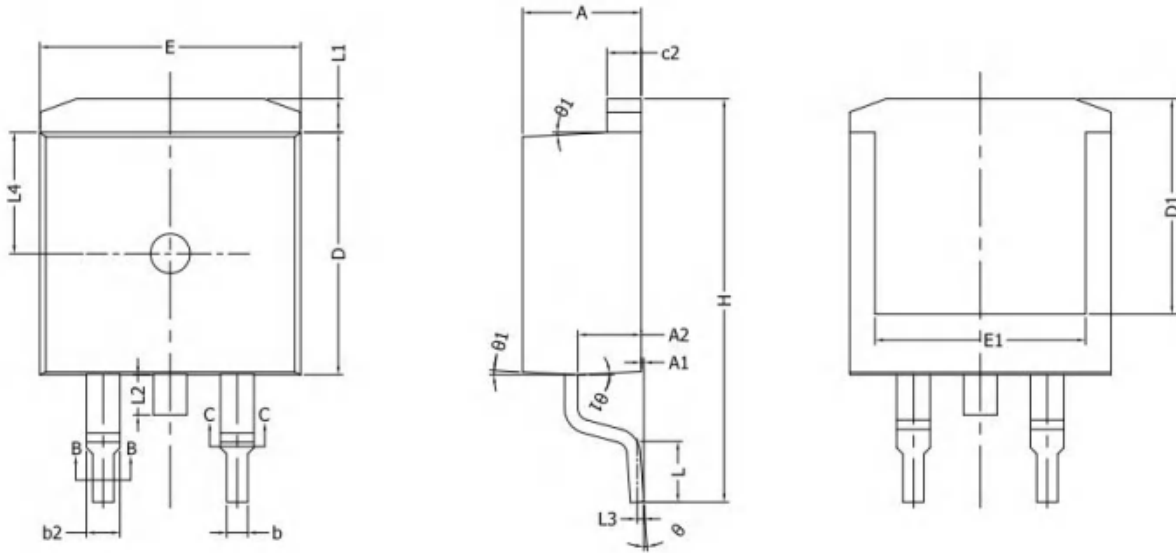

Symbol	Dimensions In Millimeters		Dimensions In Inches	
	Min.	Max.	Min.	Max.
A	4.40	4.60	0.17	0.18
A1	0.00	0.25	0.00	0.01
A2	2.20	2.60	0.09	0.10
b	0.76	0.89	0.03	0.04
b2	1.23	1.37	0.05	0.05
C	0.47	0.60	0.02	0.02
c2	1.25	1.35	0.05	0.05
D	9.10	9.30	0.36	0.37
D1	8.00	/	0.31	/
E	9.80	10.00	0.39	0.39
E1	7.80	/	0.31	/
H	14.90	15.70	0.59	0.62
L	2.00	2.60	0.08	0.10
L1	1.17	1.40	0.05	0.06
L2	/	1.75	/	0.07
L3	0.25BSC		0.01BSC	
L4	4.60REF		0.18BSC	

TO-263-3L Package Information

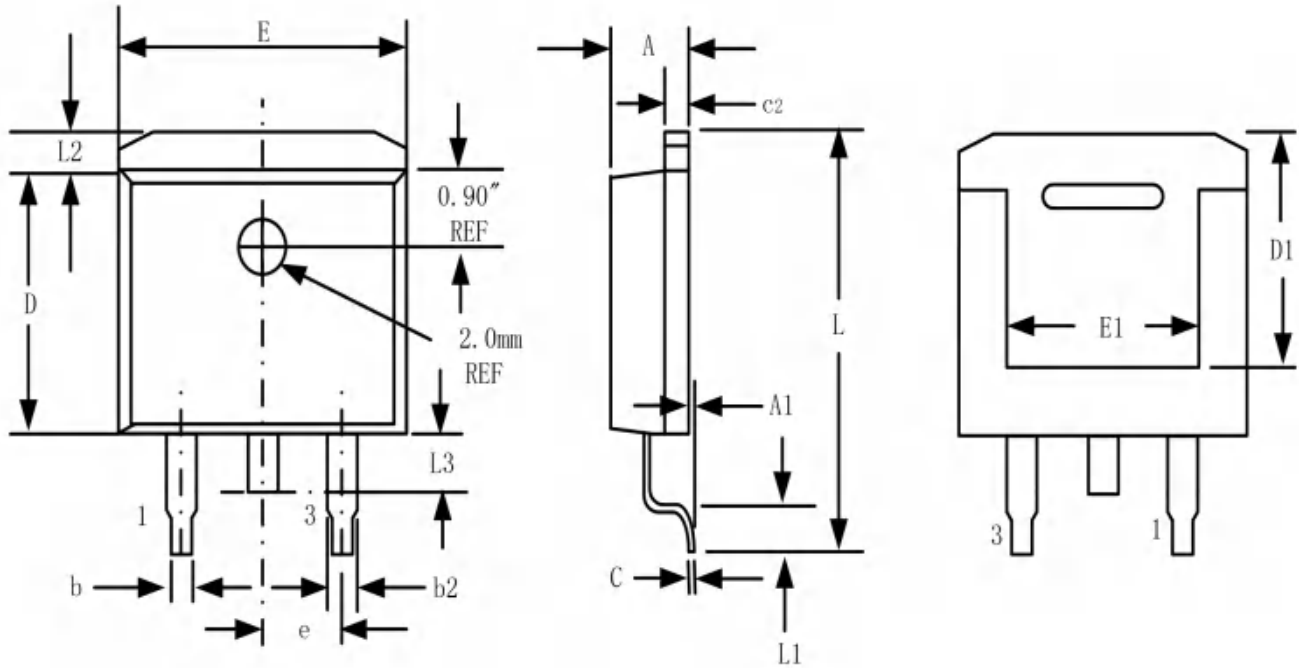

Symbol	Dimensions In Millimeters		Dimensions In Inches	
	Min.	Max.	Min.	Max.
A	4.32	4.57	0.170	0.180
A1	-	0.25		0.010
b	0.71	0.94	0.028	0.037
b2	1.15	1.40	0.045	0.055
c	0.46	0.61	0.018	0.024
c2	1.22	1.40	0.048	0.055
D	8.89	9.40	0.350	0.370
D1	8.01	8.23	0.315	0.324
E	10.04	10.28	0.395	0.405
E1	7.88	8.08	0.310	0.318
e	2.54 BSC		0.100 BSC	
L	14.73	15.75	0.580	0.620
L1	2.29	2.79	0.090	0.110
L2	1.15	1.39	0.045	0.055
L3	1.27	1.77	0.050	0.070

TO-220-3L-C Package Information

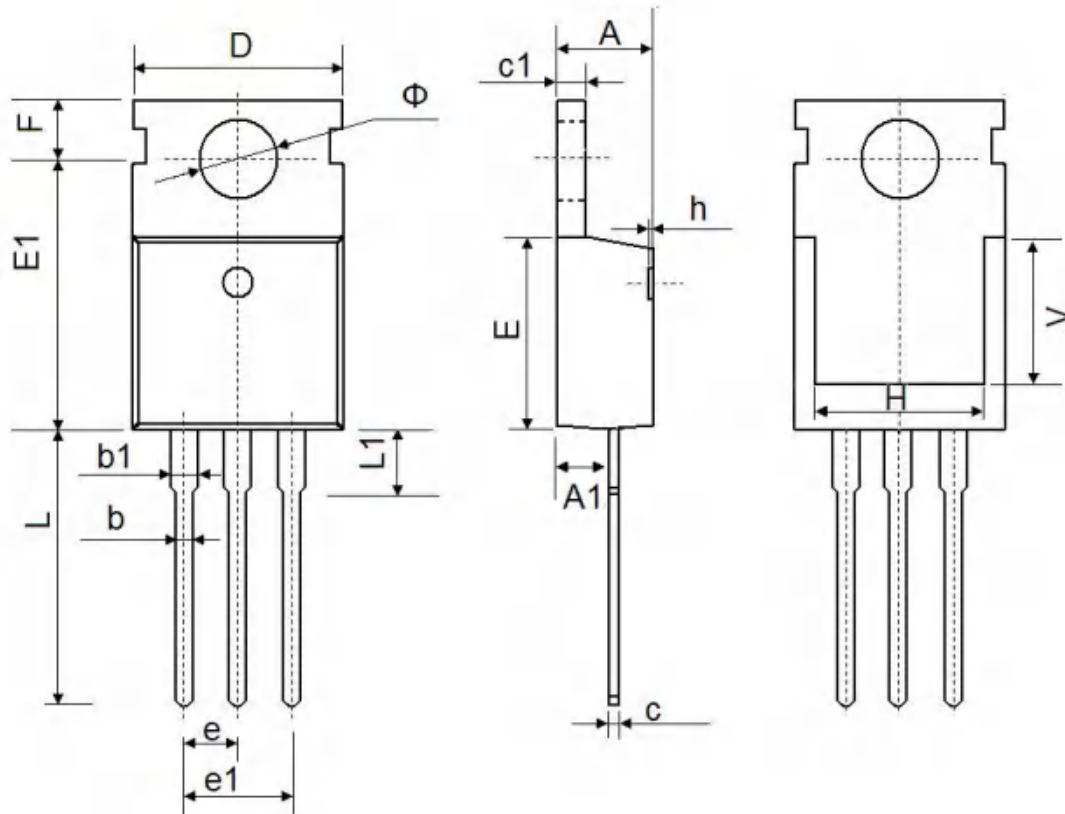

Symbol	Dimensions In Millimeters		Dimensions In Inches	
	Min.	Max.	Min.	Max.
A	4.400	4.600	0.173	0.181
A1	2.250	2.550	0.089	0.100
b	0.710	0.910	0.028	0.036
b1	1.170	1.370	0.046	0.054
c	0.330	0.650	0.013	0.026
c1	1.200	1.400	0.047	0.055
D	9.910	10.250	0.390	0.404
E	8.9500	9.750	0.352	0.384
E1	12.650	12.950	0.498	0.510
e	2.540 TYP.		0.100 TYP.	
e1	4.980	5.180	0.196	0.204
F	2.650	2.950	0.104	0.116
H	7.900	8.100	0.311	0.319
h	0.000	0.300	0.000	0.012
L	12.900	13.400	0.508	0.528
L1	2.850	3.250	0.112	0.128
V	7.500 REF.		0.295 REF.	
Φ	3.400	3.800	0.134	0.150

TO-220F Package Information

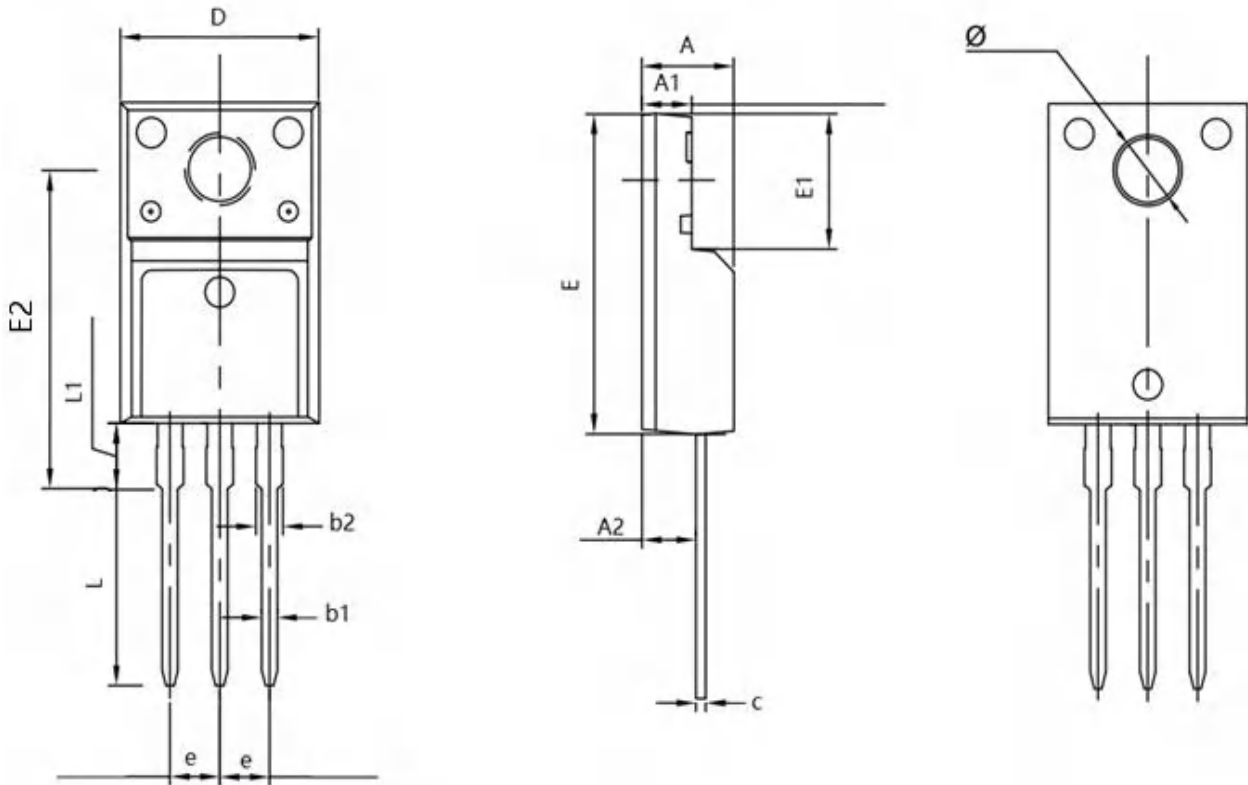

Symbol	Dimensions In Millimeters		Dimensions In Inches	
	Min.	Max.	Min.	Max.
A	4.500	4.900	0.177	0.193
A1	2.340	2.740	0.092	0.108
A2	2.560	2.960	0.101	0.117
b1	0.700	0.900	0.028	0.035
b2	1.180	1.580	0.046	0.062
c	0.400	0.600	0.016	0.024
D	9.960	10.360	0.392	0.408
E	15.670	15.970	0.617	0.629
E1	6.500	6.900	0.256	0.272
E2	15.500	16.100	0.610	0.634
e	2.540 TYP		0.100 TYP	
\varnothing	3.080	3.280	0.121	0.129
L	12.640	13.240	0.498	0.521
L1	3.030	3.430	0.119	0.135

ATTENTION

QIAOXIN assumes no responsibility for equipment failures that result from using products at values that exceed, even momentarily, rated values (such as maximum ratings, operating condition ranges, or other parameters) listed in products specifications of any and all QIAOXIN products described or contained herein. QIAOXIN products are not designed for use in life support appliances, devices or systems where malfunction of these products can be reasonably expected to result in personal injury. Reproduction in whole or in part is prohibited without the prior written consent of the copyright owner. QIAOXIN reserves the right to make changes to information published in this document, including without limitation specifications and product descriptions, at any time and without notice. This document supersedes and replaces all information supplied prior to the publication hereof.